



www.IranEbara.com



	Page
- SPECIFICATIONS	200
SELECTION CHART	201
TYPE KEY AND CURVE SPECIFICATIONS	203
PERFORMANCE CURVE LPC4 32	205
PERFORMANCE CURVE LPC4 40	206
PERFORMANCE CURVE LPC4 50	211
PERFORMANCE CURVE LPC4 65	215
PERFORMANCE CURVE LPC4 80	219
PERFORMANCE CURVE LPC4 100	222
PERFORMANCE CURVE LPC4 125	225
PERFORMANCE CURVE LPC4 150	226
- CONSTRUCTIONS	300
SECTIONAL VIEW	300
MECHANICAL SEAL	302
- DIMENSIONS AND WEIGHT	400
PUMP	400
- TECHNICAL DATA	500
MOTOR DATA	500
NOISE DATA	501

SPECIFICATION

50Hz

Rev. A

PUMP		
Liquid Handled	Type of liquid	Clean water
	Temperature [°C]	min. -10 max +110
	Viscosity [cSt]	max 38
Maximum ambient temperature [°C]		40 (over ask for det ails)
Maximum working pressure [MPa]		1.0
Construction	Impeller	Closed centrifugal type
	Shaft seal type	Mechanical seal
	Bearing	On the motor
Pipe Connection	Suction	PN10 (LPC4 32-100 – LPC4 40-100) DIN 2501 UNI 2223-29 PN16 all other models DIN 2501
	Discharge	PN10 (LPC 32-100 – LPC 40-100) DIN 2501 UNI 2223-29 PN16 all other models DIN 2501
Material	Casing	CAST IRON
	Impeller	CAST IRON
	Casing cover	CAST IRON
	Shaft seal	Carbon/SiC/EPDM
	Shaft	AISI 420
	Bracket	CAST IRON
Applicable standard of test		ISO 9906 – Annex A

MOTOR	
Type	Electric - TEFC Three Phase
Efficiency level (Reg. 640/2009)	- from 0.37 kW up to 0.55 kW IE2 from 0.75 kW up to 5.5 kW IE3 from 7.5 kW up to 15 kW
No. of Poles	4
Rotation speed [min ⁻¹]	≈1400
Insulation Class	F
Protection degree (CEI EN 60034-5)	IP 55
Power rating [kW]	0.25 ÷ 15
[HP]	0.33 ÷ 20
Frequency [Hz]	50
Voltage [V]	230/400 ±10% (up to 4 kW) 400/690 ±10% (5.5kW and above)
Over load protection	Provided by the user
Casing material	Aluminium

Poles

SELECTION CHART

50Hz

Rev. A

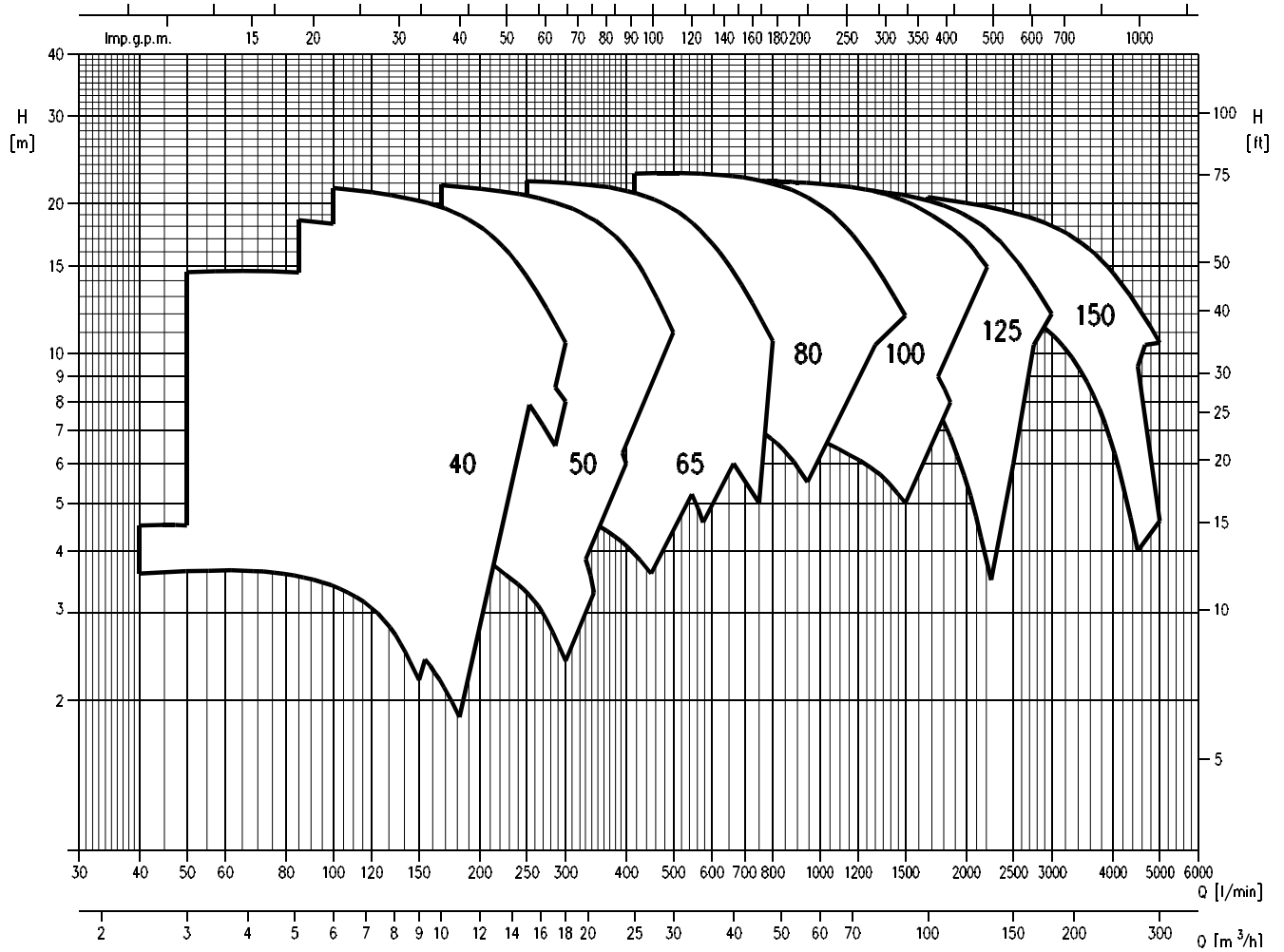

TYPE KEY AND CURVE SPECIFICATIONS

50Hz

Rev. A

TYPE KEY:

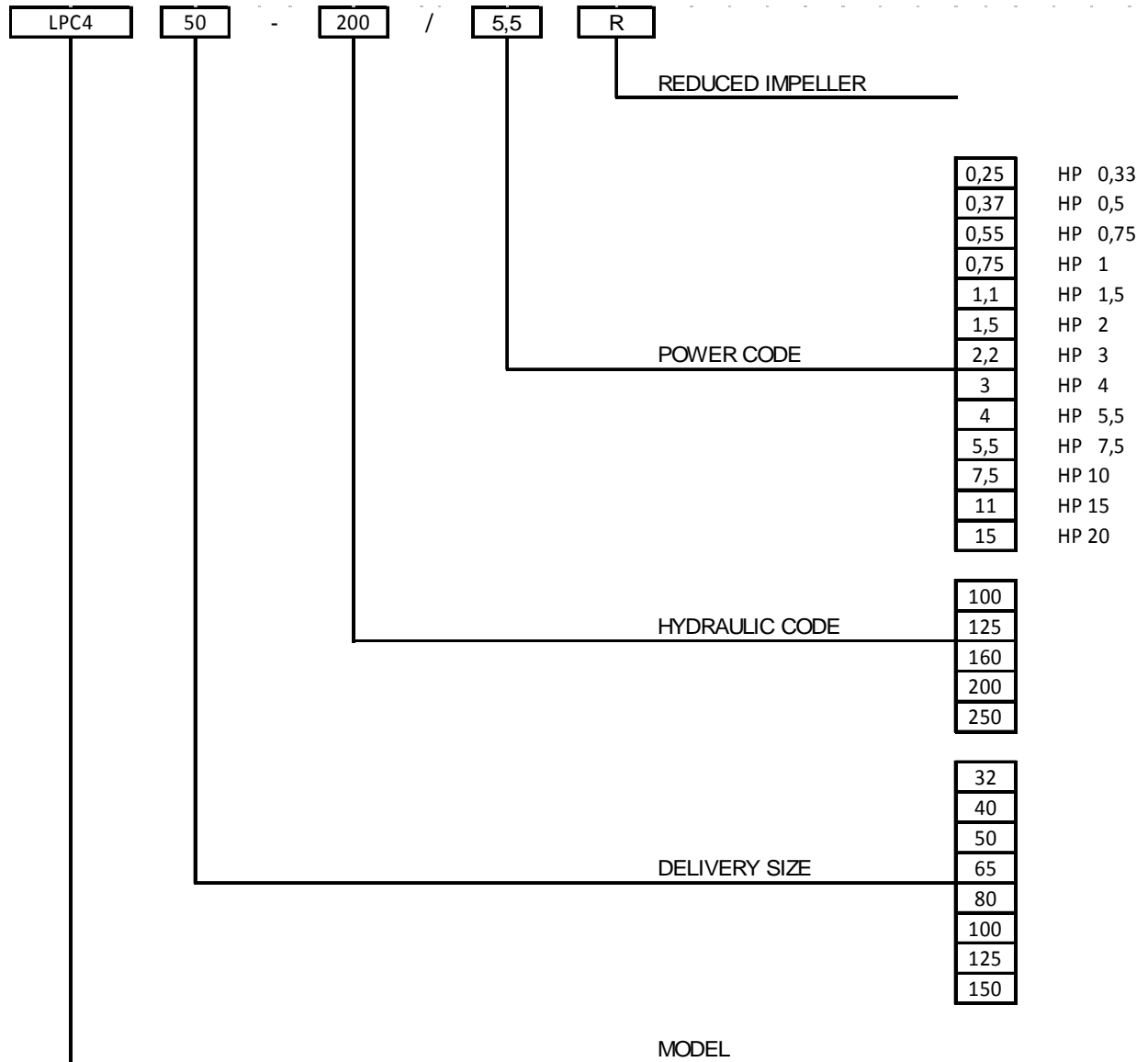

PERFORMANCE CURVE SPECIFICATIONS

The specifications below qualify the curves shown on the following pages.

Tolerances according to ISO 9906 Annex A

The curves refer to effective speed of asynchronous motors at 50 Hz

Measurements were carried out with clean water at 20°C of temperature and with a kinematic viscosity of $\nu = 1 \text{ mm}^2/\text{s}$ (1 cSt)

The NPSH curve is an average curve obtained in the same conditions of performance curves.

The continuous curves indicate the recommended working range. The dotted curve is only a guide.

In order to avoid the risk of over-heating, the pumps should not be used at a flow rate below 10% of best efficiency point.

Symbols explanation:

- Q = volume flow rate
- H = total head
- P_2 = pump power input (shaft power)
- η = pump efficiency
- NPSH = net positive suction head required by the pump
- MEI = minimum efficiency index

The minimum efficiency index (MEI) is a measure of the quality of a pump size in respect to its mean efficiency. The minimum efficiency index is based on the hydraulic efficiency and on the head at the best efficiency point.

The efficiency of a pump with trimmed impeller is usually lower than that of a pump with the full impeller diameter. The trimming of the impeller will adapt the pump to a fixed duty point, leading to reduced energy consumption. The minimum efficiency index (MEI) is based on the full impeller diameter.

The operation of these water pumps with variable duty points may be more efficient and economic when controlled, for example, by the use of a variable speed drive that matches the pump duty to the system.

MEI = 0.4 for ESCCi 1450 rpm

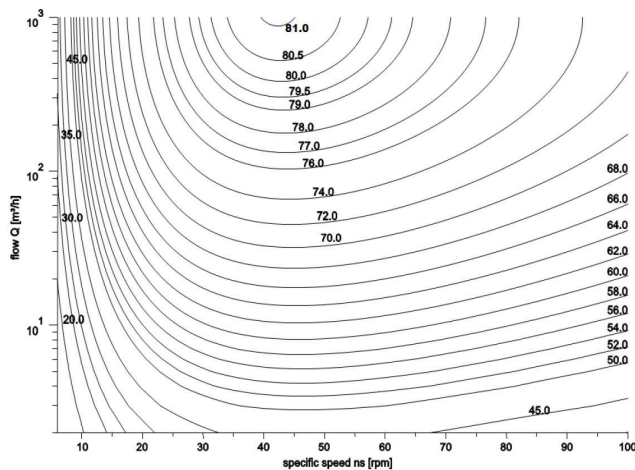

MEI = 0.7 for ESCCi 1450rpm

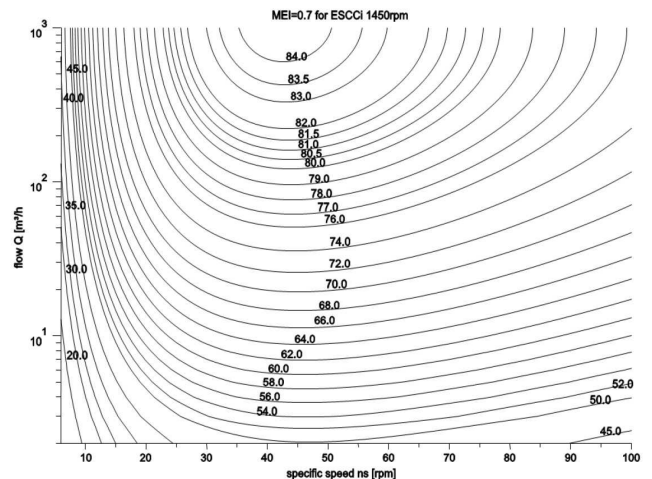

LPC4 32-100/0.25 (0.25 kW) MEI > 0.40 Impeller diameter = 99 mm

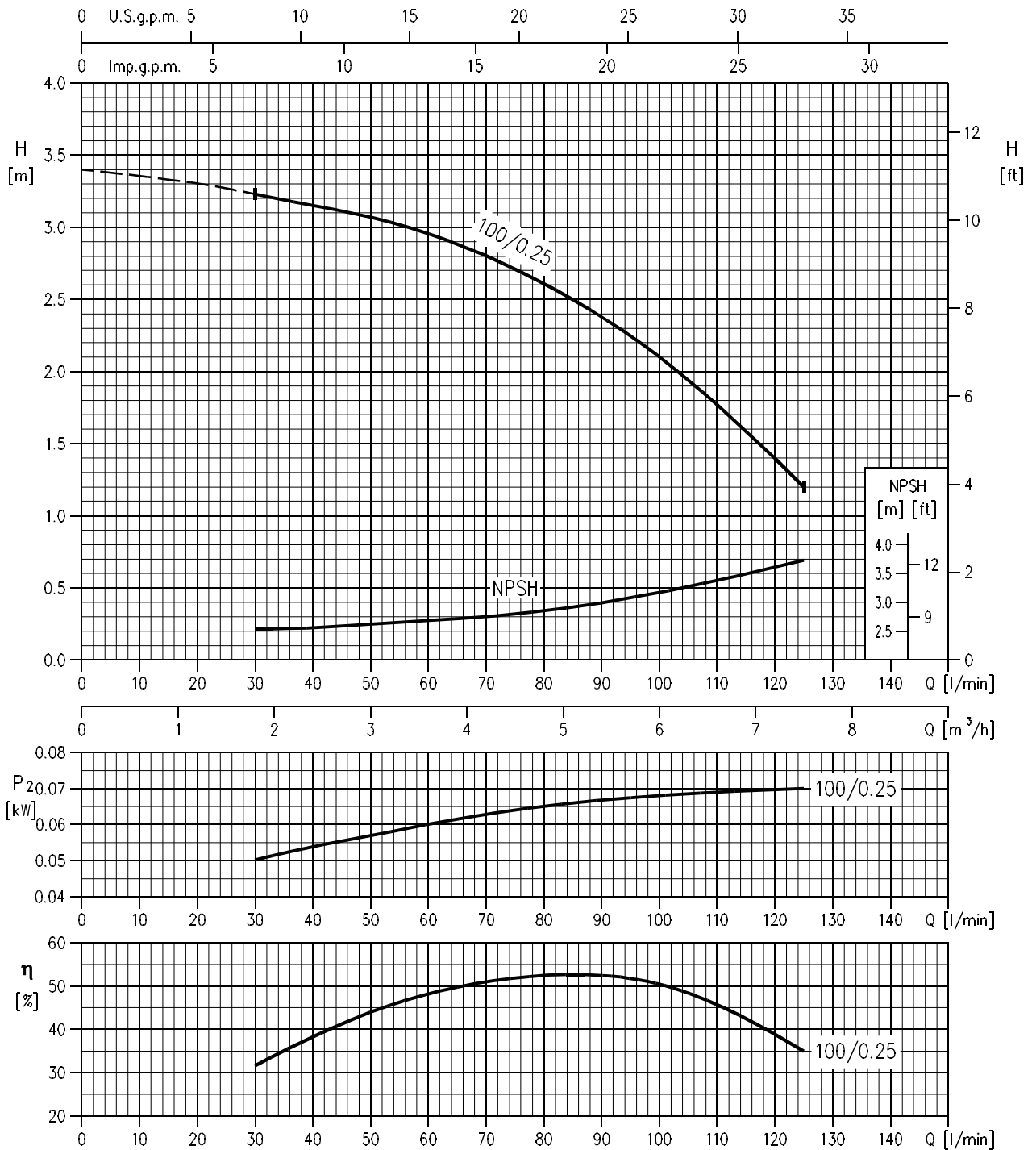

Rotation speed ≈ 1400 min⁻¹
 Test standard: ISO 9906 – Annex A

LPC4 40-100/0.25 (0.25 kW) MEI > 0.40 Impeller diameter = 105 mm

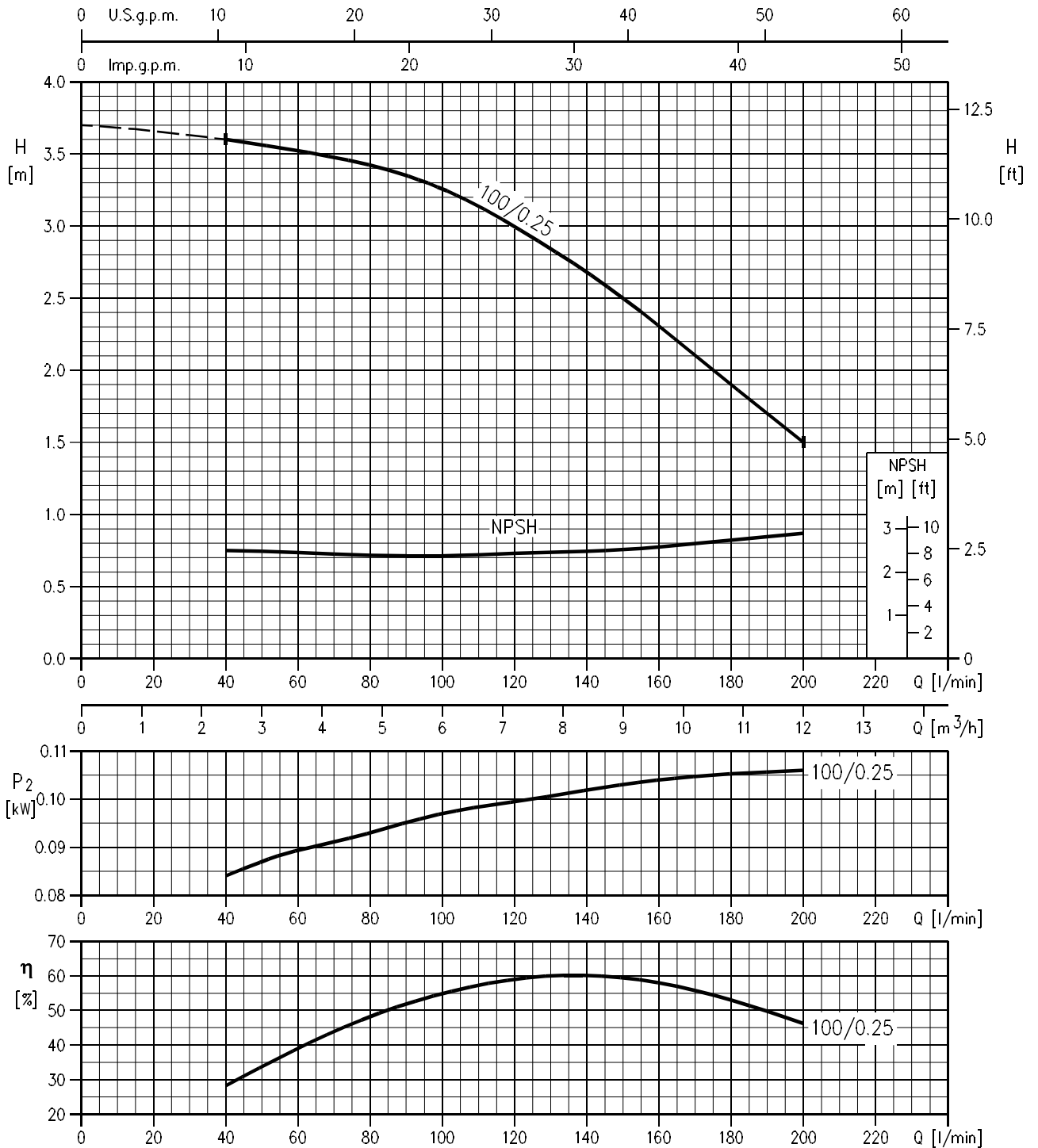

Rotation speed ≈ 1400 min⁻¹
 Test standard: ISO 9906 – Annex A

PERFORMANCE CURVE

50Hz

Rev. A

LPC4 40-125/0.25R (0.25 kW) MEI > 0.40 Impeller diameter = 120 mm
 LPC4 40-125/0.25 (0.25 kW) MEI > 0.40 Impeller diameter = 139 mm

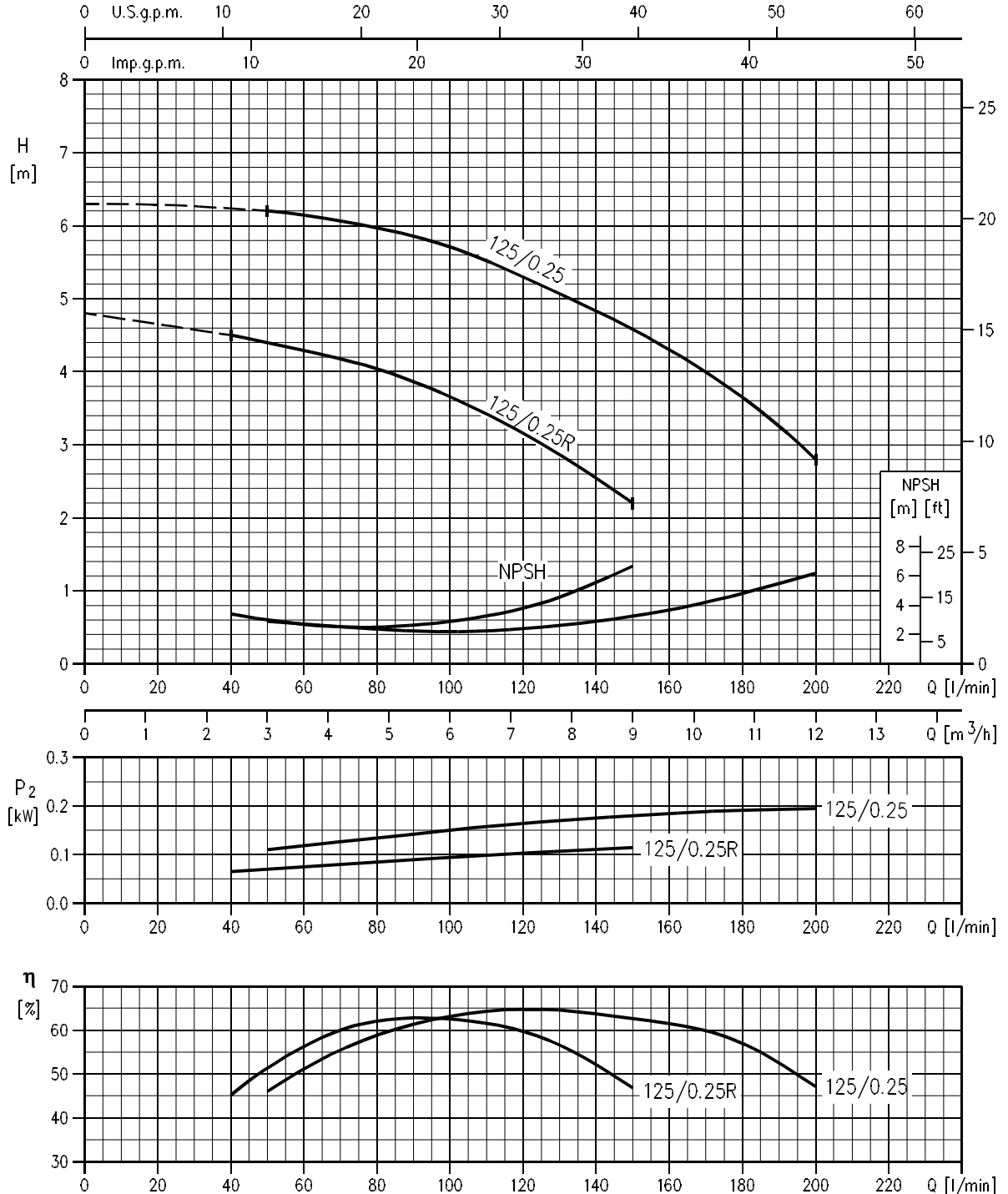

Rotation speed ≈ 1400 min⁻¹
 Test standard: ISO 9906 – Annex A

LPC4 40-160/0.37 (0.37 kW) MEI > 0.40 Impeller diameter = 169 mm

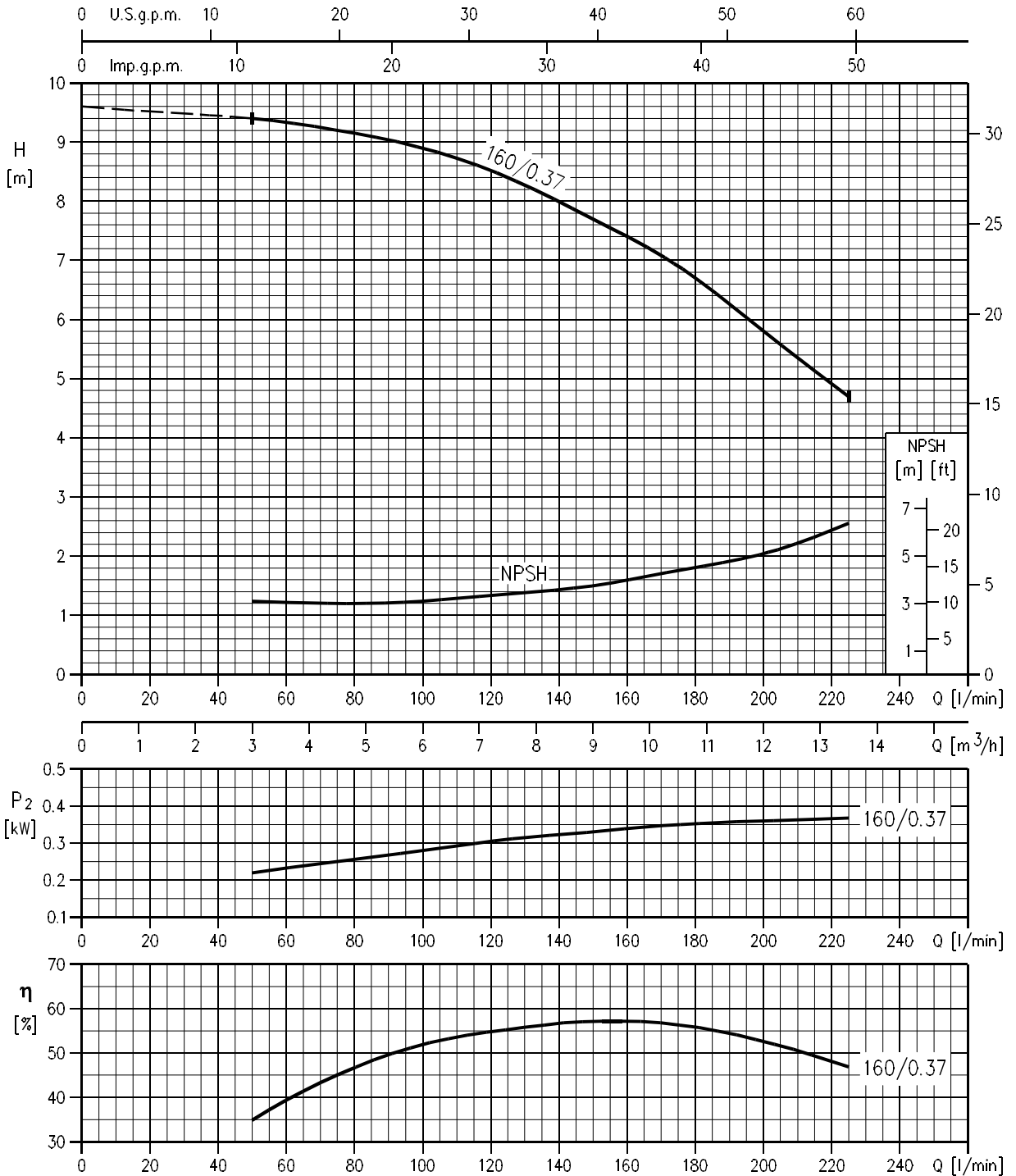

Rotation speed ≈ 1400 min⁻¹
 Test standard: ISO 9906 – Annex A

LPC4 40-200/0.75 (0.75 kW) MEI > 0.40 Impeller diameter = 200 mm
 LPC4 40-200/1.1 (1.1 kW) MEI > 0.40 Impeller diameter = 209 mm

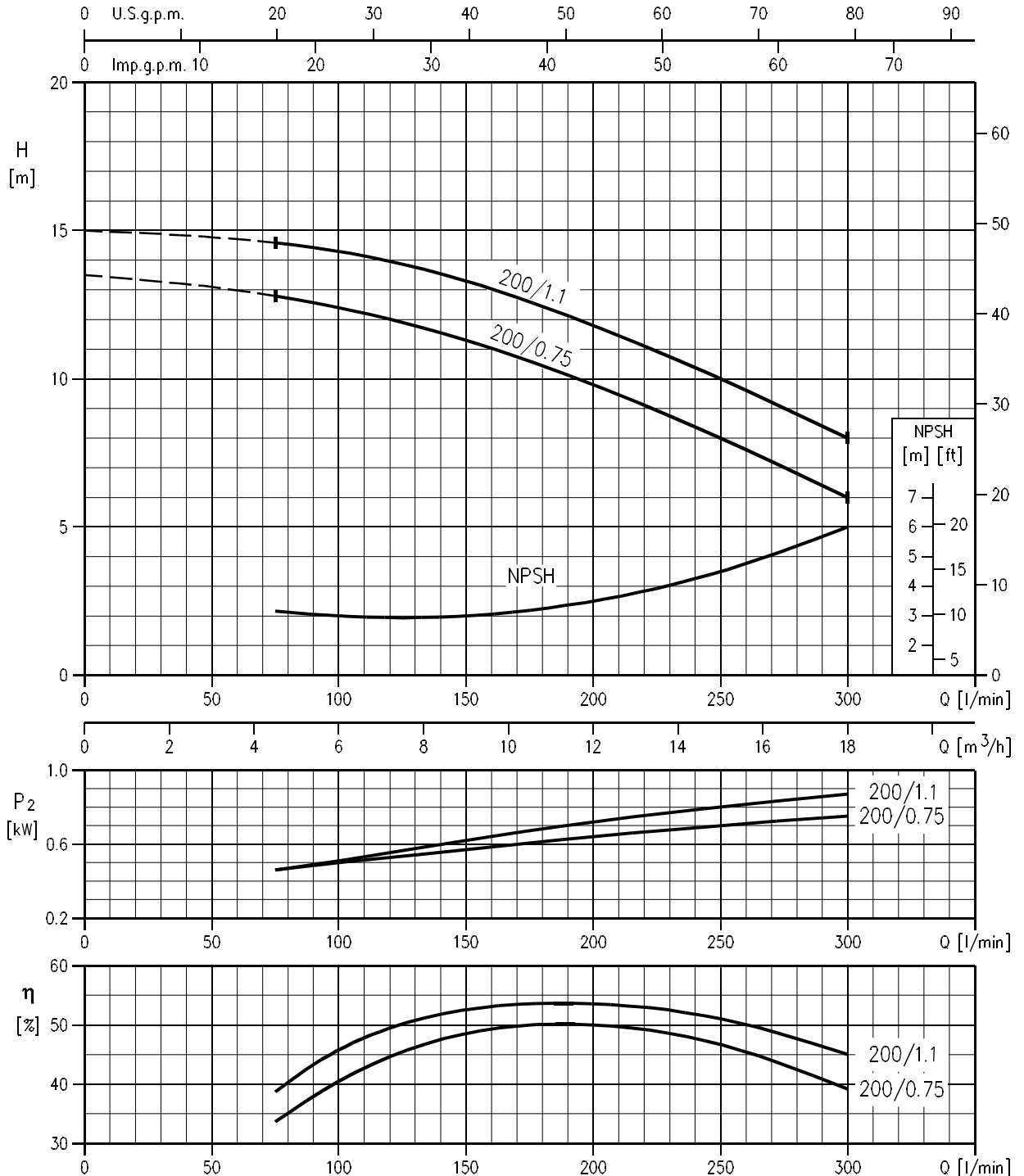

Rotation speed ≈ 2900 min⁻¹
 Test standard: ISO 9906 – Annex A

PERFORMANCE CURVE

50Hz

Rev. A

LPC4 40-250/1.1 (1.1 kW) MEI > 0.40 Impeller diameter = 240 mm
 LPC4 40-250/01.5 (1.5 kW) MEI > 0.40 Impeller diameter = 260.5 mm

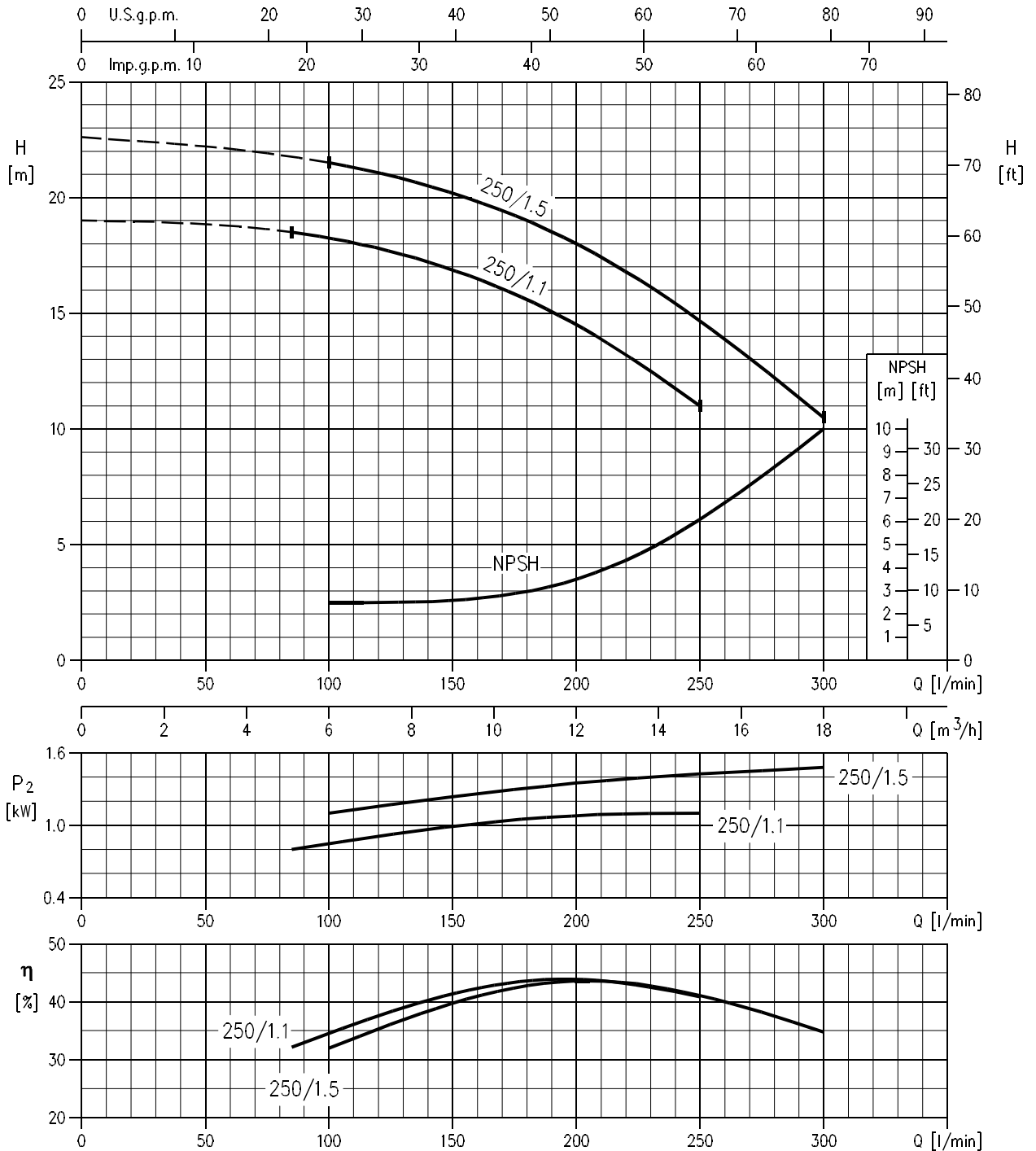

Rotation speed ≈ 1400 min⁻¹
 Test standard: ISO 9906 – Annex A

PERFORMANCE CURVE

50Hz

Rev. A

LPC4 50-125/0.25 (0.25 kW) MEI > 0.40 Impeller diameter = 129 mm
 LPC4 50-125/0.37 (0.37 kW) MEI > 0.40 Impeller diameter = 140.5 mm

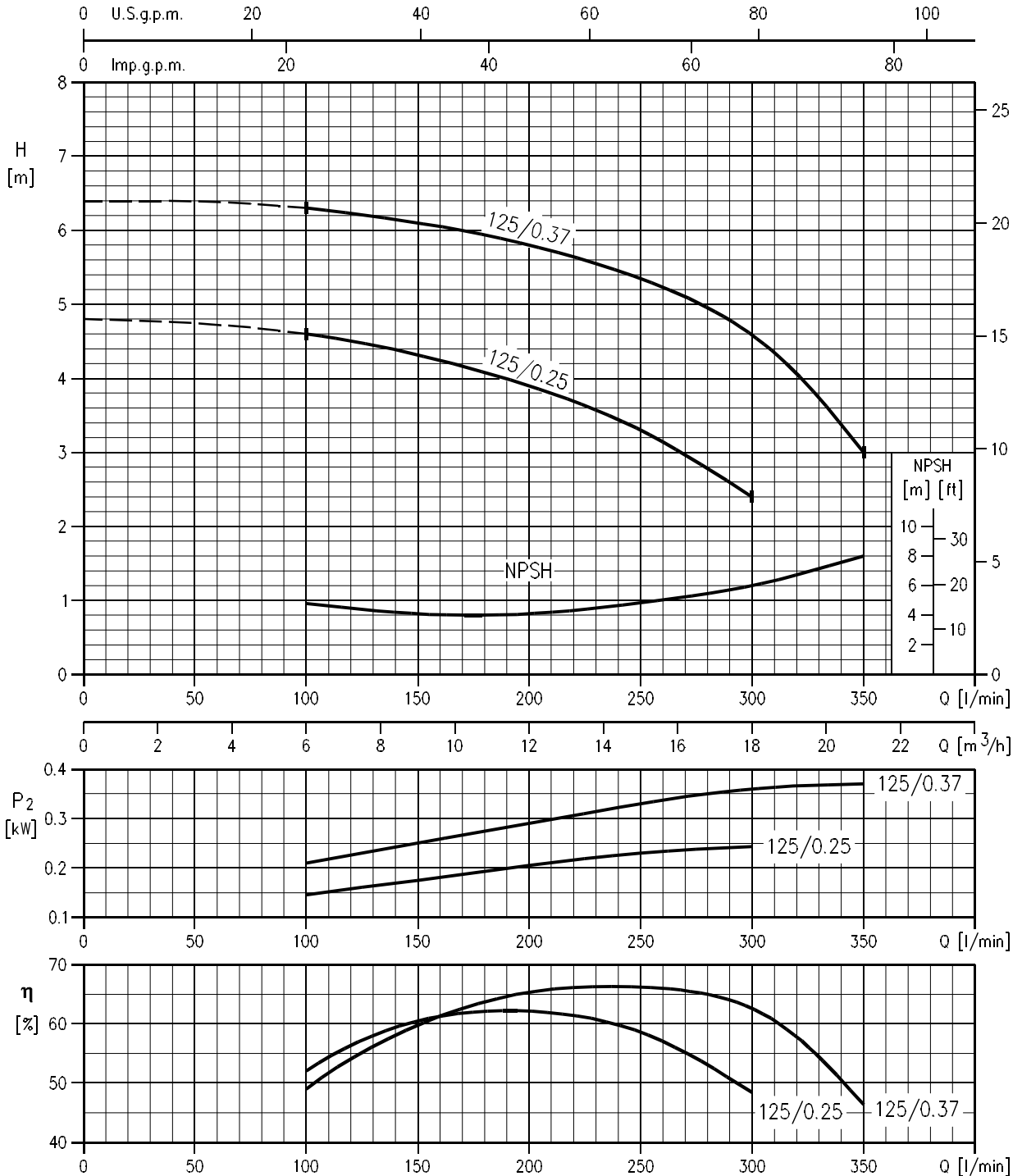

Rotation speed ≈ 1400 min⁻¹
 Test standard: ISO 9906 – Annex A

LPC4 50-160/0.55 (0.55 kW) MEI > 0.40 Impeller diameter = 169 mm

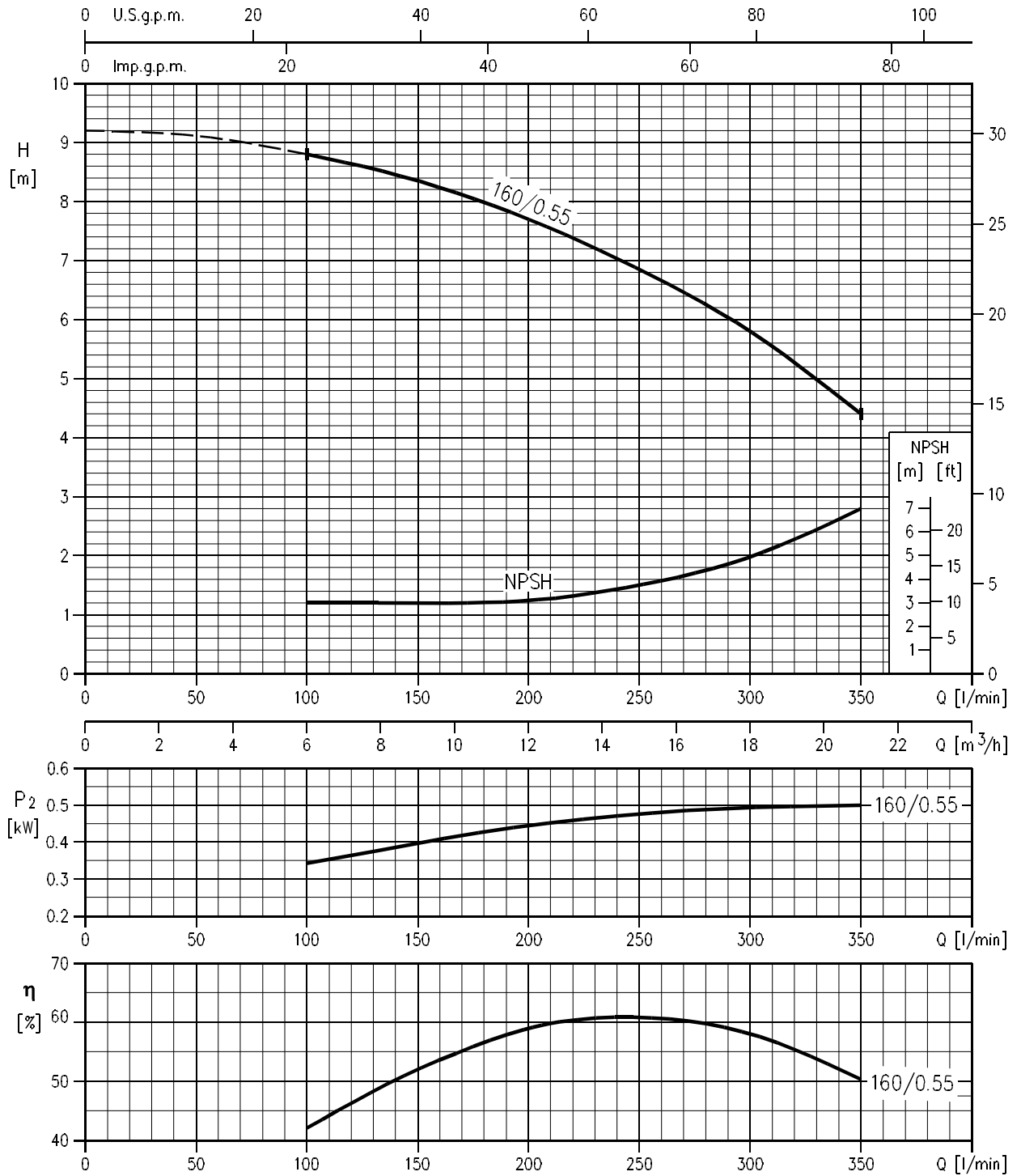

Rotation speed ≈ 1400 min⁻¹
 Test standard: ISO 9906 – Annex A

PERFORMANCE CURVE

50Hz

Rev. A

LPC4 50-200/1.1R (1.1 kW) MEI > 0.40 Impeller diameter = 201 mm
 LPC4 50-200/1.1 (1.1 kW) MEI > 0.40 Impeller diameter = 210 mm

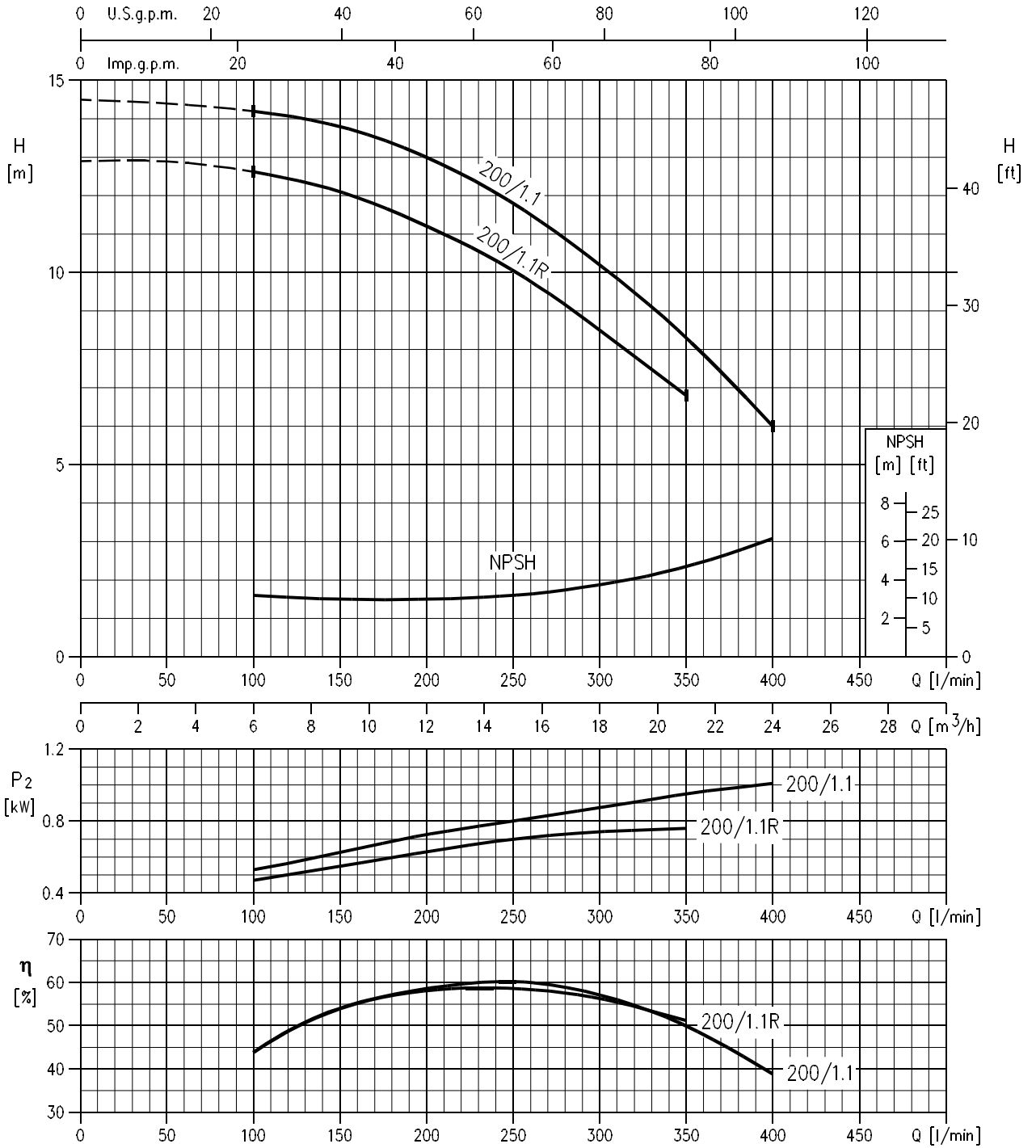

Rotation speed ≈ 1400 min⁻¹
 Test standard: ISO 9906 – Annex A

PERFORMANCE CURVE

50Hz

Rev. A

LPC4 50-250/1.5 (1.5 kW) MEI > 0.40 Impeller diameter = 240 mm
 LPC4 50-250/2.2 (2.2 kW) MEI > 0.40 Impeller diameter = 259 mm

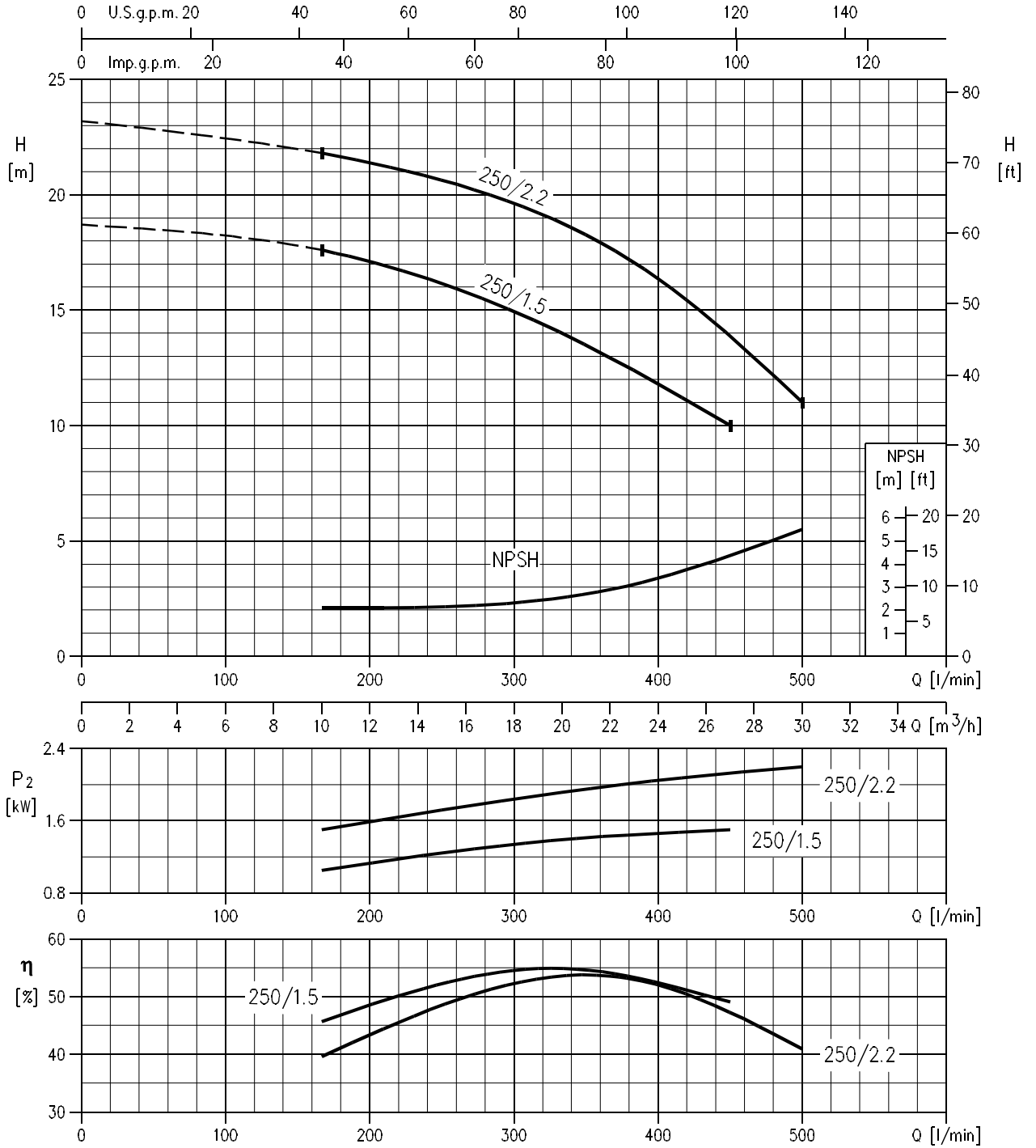

Rotation speed ≈ 1400 min⁻¹
 Test standard: ISO 9906 – Annex A

PERFORMANCE CURVE

50Hz

Rev. A

LPC4 65-125/0.37 (0.37 kW) MEI > 0.40 Impeller diameter = 130 mm
 LPC4 65-125/0.55 (0.55 kW) MEI > 0.40 Impeller diameter = 139 mm

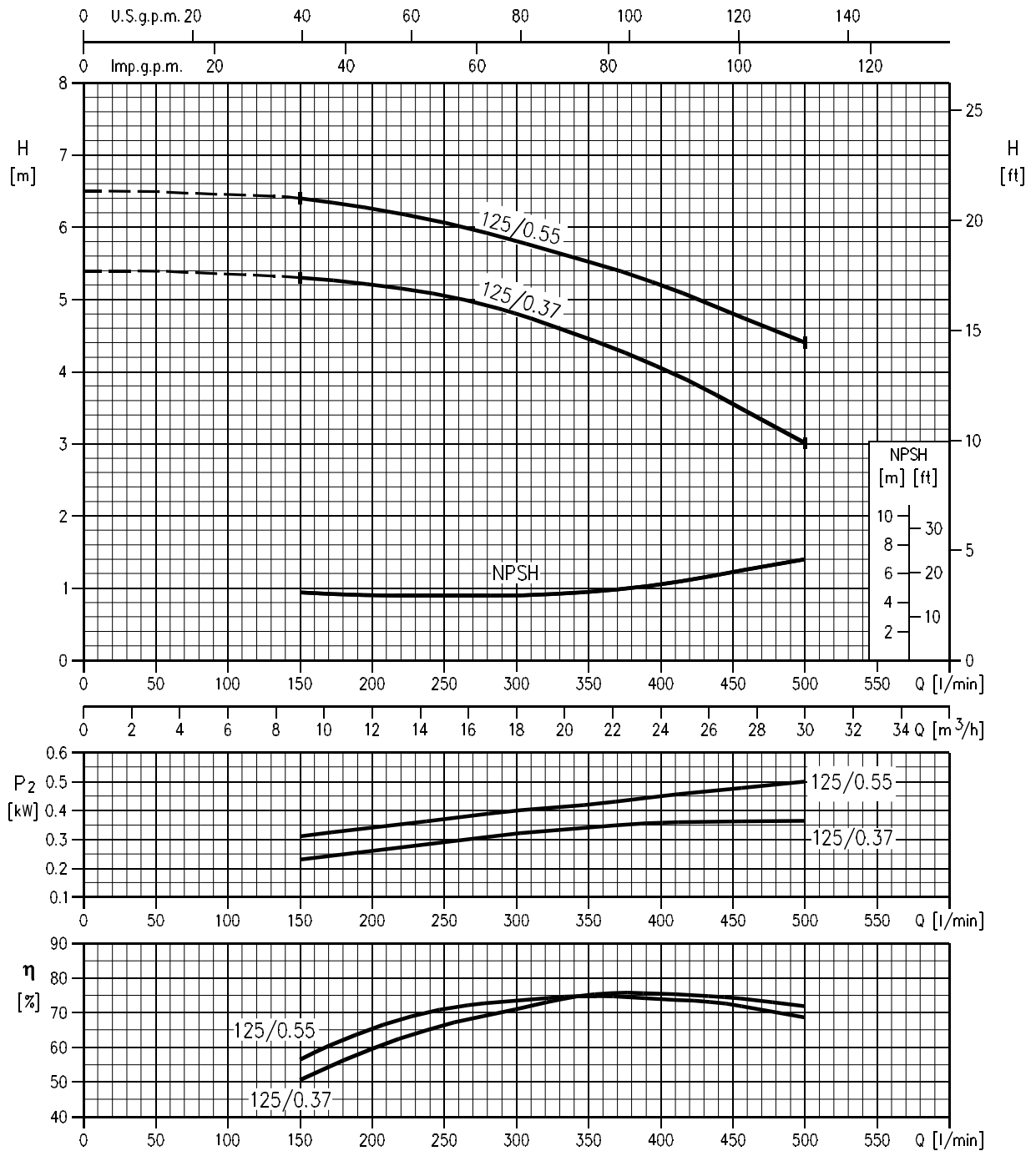

Rotation speed ≈ 1400 min⁻¹
 Test standard: ISO 9906 – Annex A

PERFORMANCE CURVE

50Hz

Rev. A

LPC4 65-160/0.75 (0.75 kW) MEI > 0.40 Impeller diameter = 160 mm
 LPC4 65-160/1.1 (1.1 kW) MEI > 0.40 Impeller diameter = 169 mm

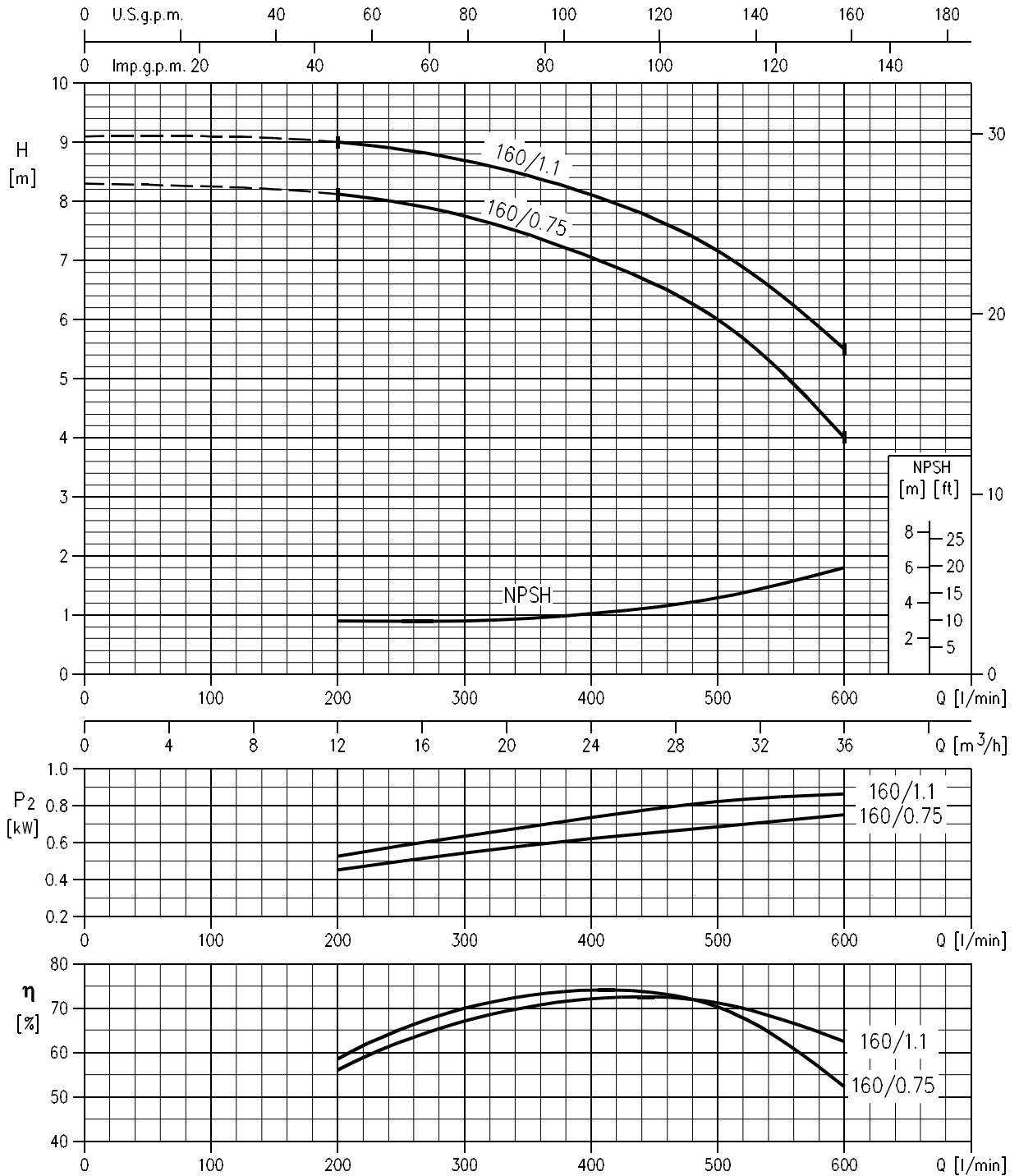

Rotation speed ≈ 1400 min⁻¹
 Test standard: ISO 9906 – Annex A

LPC4 65-200/1.1 (1.1 kW) MEI > 0.40 Impeller diameter = 200 mm
 LPC4 65-200/1.5 (1.5 kW) MEI > 0.40 Impeller diameter = 209 mm

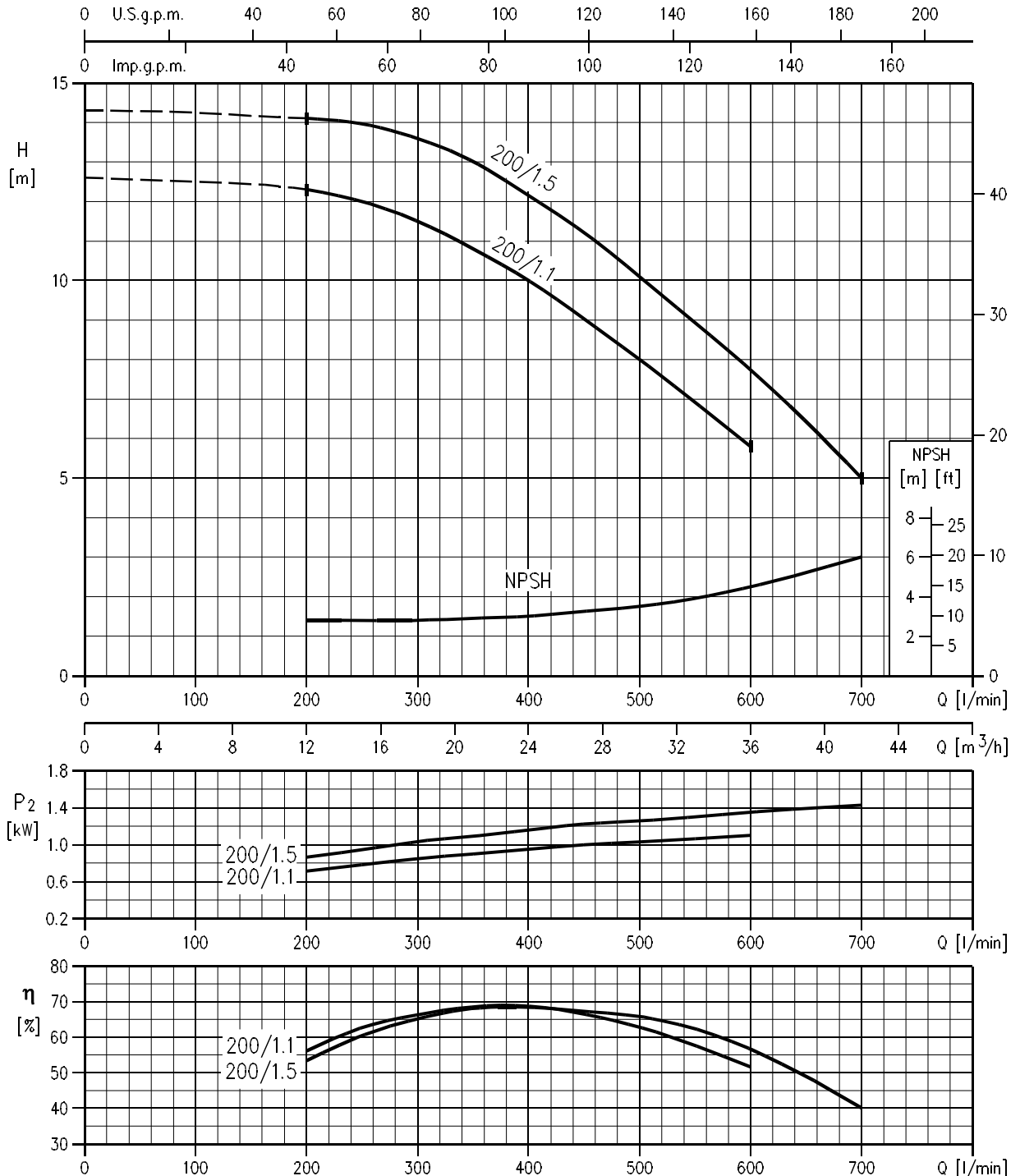

Rotation speed ≈ 1400 min⁻¹
 Test standard: ISO 9906 – Annex A

PERFORMANCE CURVE

50Hz

Rev. A

LPC4 65-250/2.2 (2.2 kW) MEI > 0.40 Impeller diameter = 235 mm
 LPC4 65-250/3.0 (3.0 kW) MEI > 0.40 Impeller diameter = 259 mm

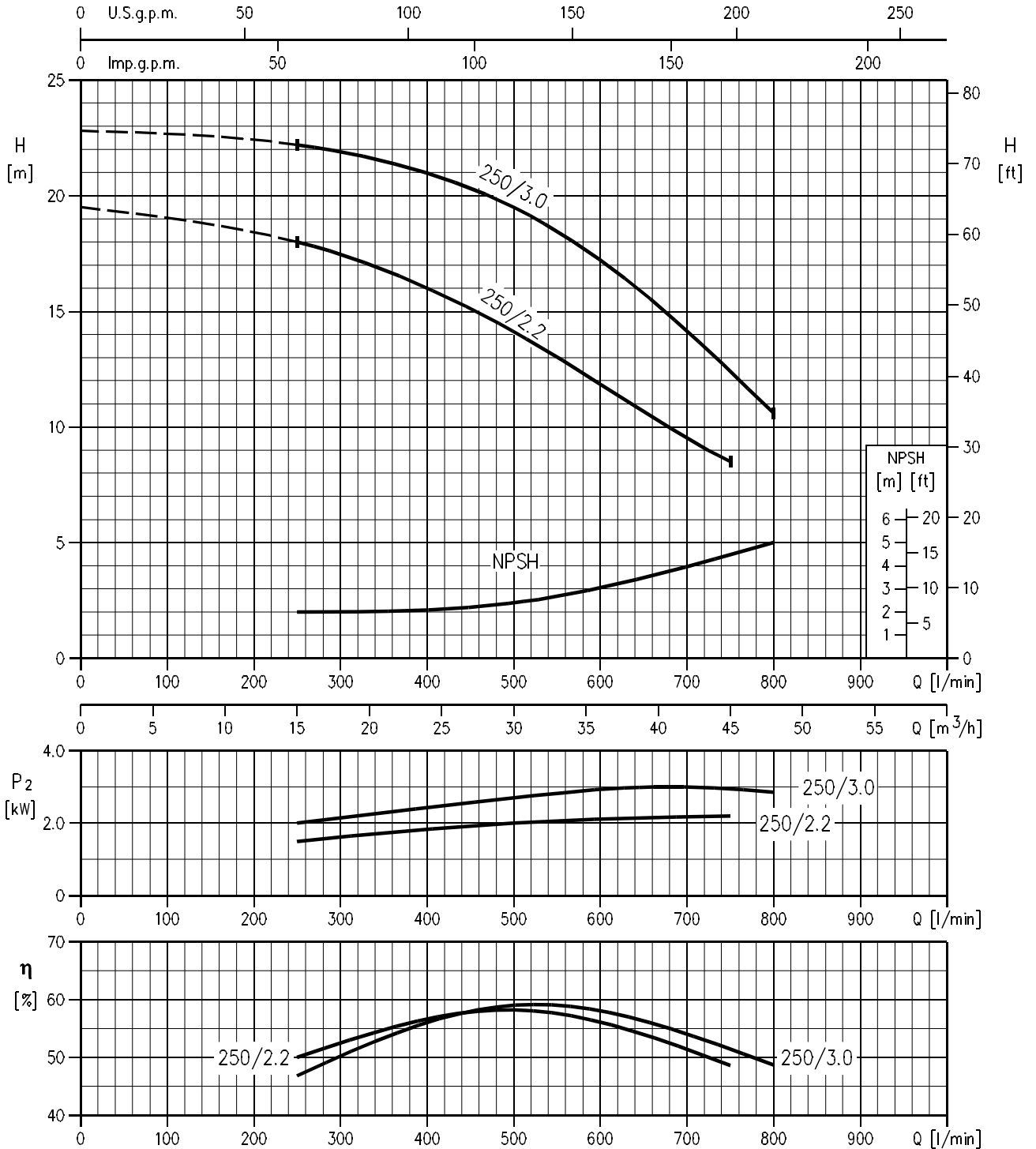

Rotation speed ≈ 1400 min⁻¹
 Test standard: ISO 9906 – Annex A

PERFORMANCE CURVE

50Hz

Rev. A

LPC4 80-160/0.75 (0.75 kW) MEI > 0.40 Impeller diameter = 138 mm
 LPC4 80-160/1.1R (1.1 kW) MEI > 0.40 Impeller diameter = 148 mm
 LPC4 80-160/1.1 (1.1 kW) MEI > 0.40 Impeller diameter = 158 mm
 LPC4 80-160/1.5 (1.5 kW) MEI > 0.40 Impeller diameter = 169 mm

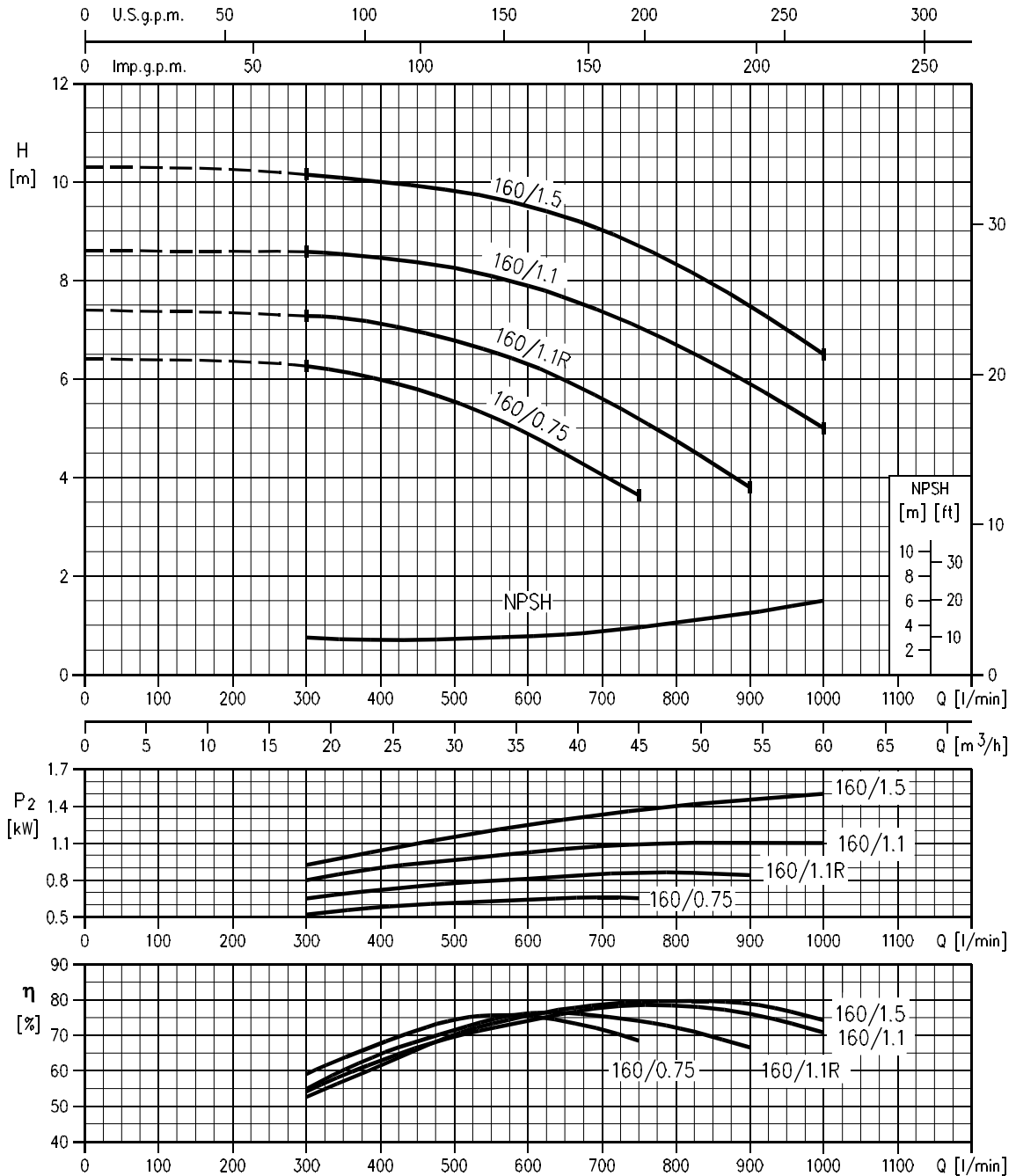

Rotation speed ≈ 1400 min⁻¹
 Test standard: ISO 9906 – Annex A

LPC4 80-200/2.2 (2.2 kW) MEI > 0.40 Impeller diameter = 192 mm
 LPC4 80-200/3.0 (3.0 kW) MEI > 0.40 Impeller diameter = 210.5 mm

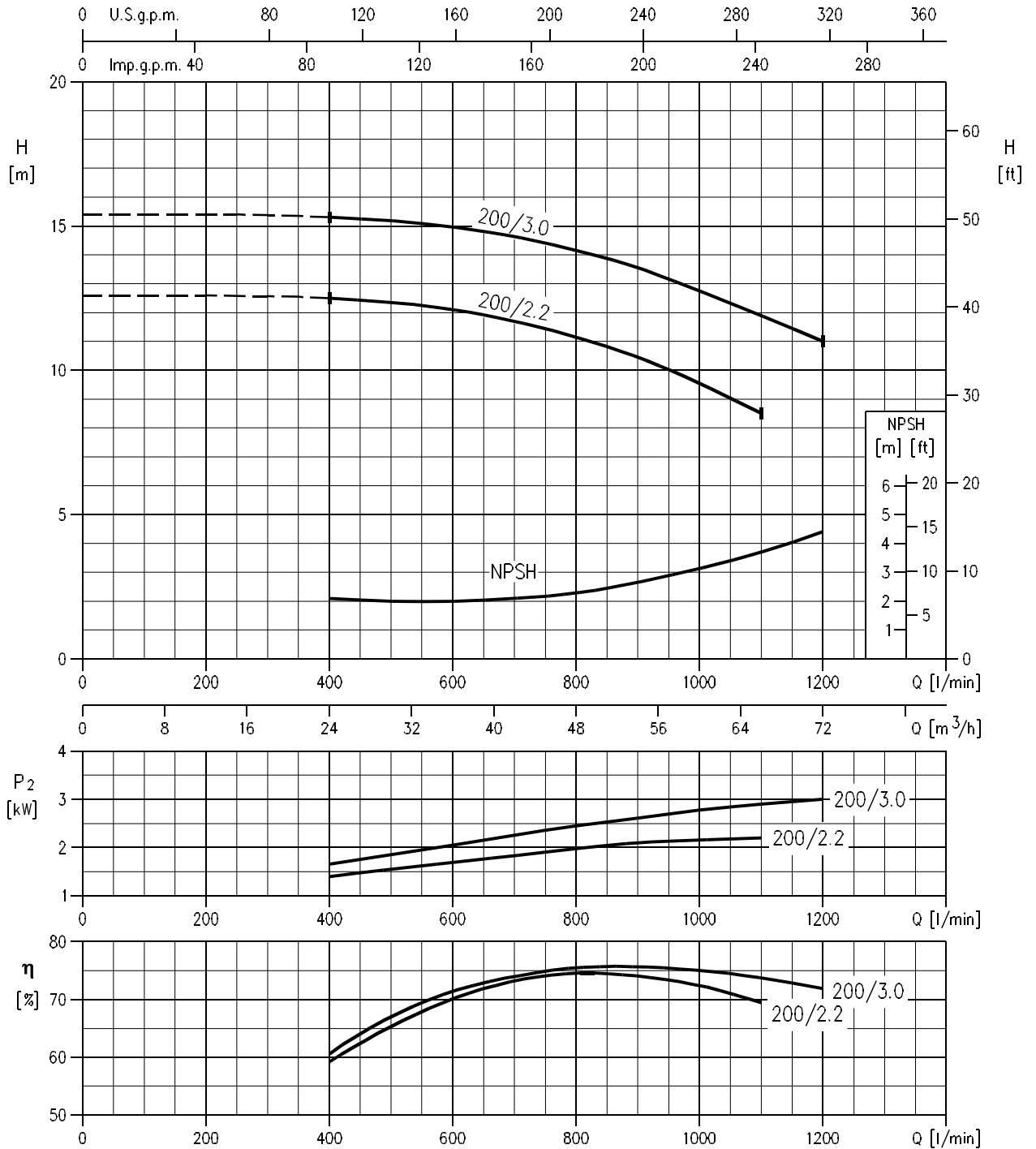

Rotation speed ≈ 1400 min⁻¹
 Test standard: ISO 9906 – Annex A

PERFORMANCE CURVE

50Hz

Rev. A

LPC4 80-250/4.0 (4.0 kW) MEI > 0.40 Impeller diameter = 245 mm
LPC4 80-250/5.5 (5.5 kW) MEI > 0.40 Impeller diameter = 259 mm

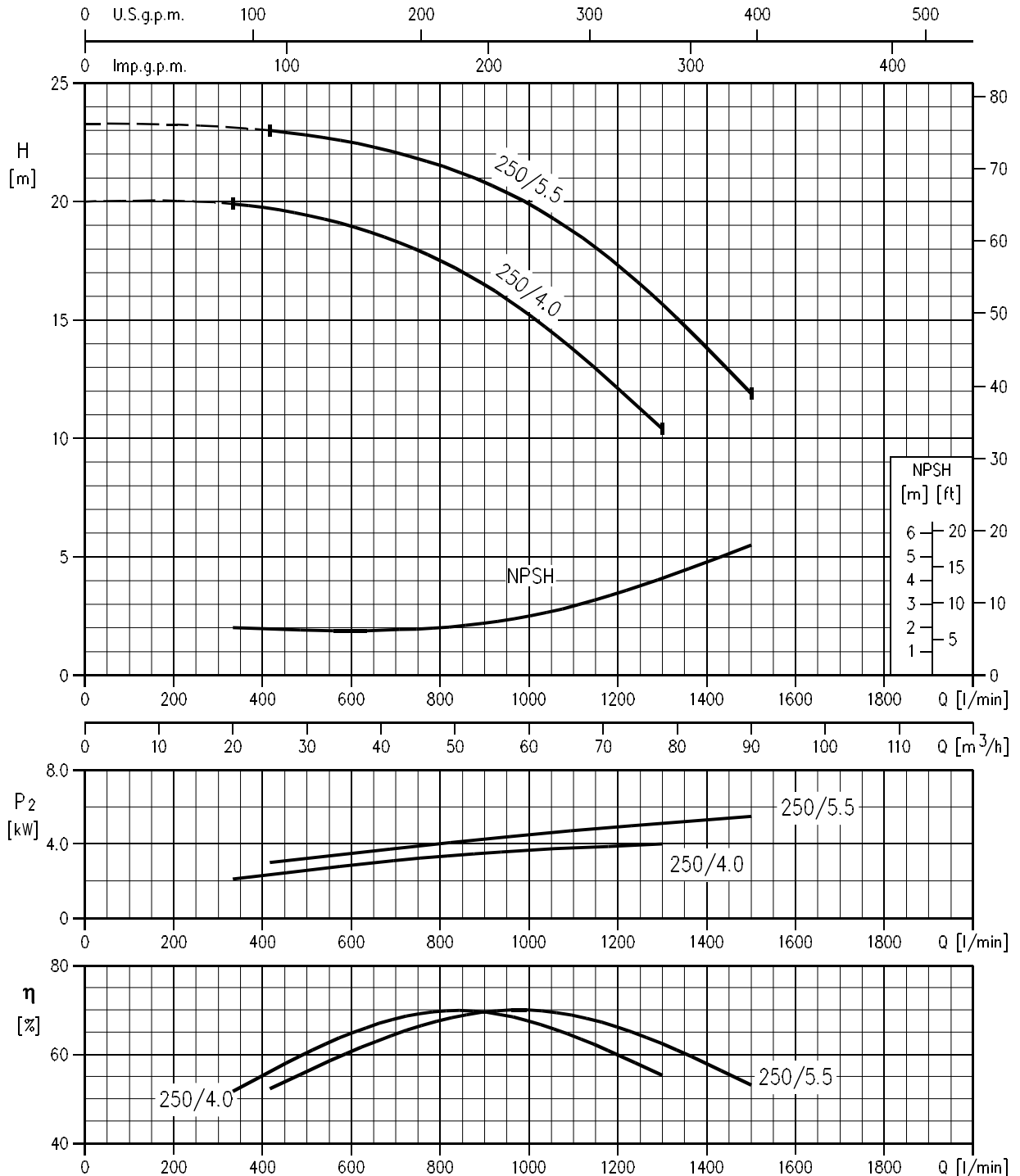

Rotation speed ≈ 1400 min⁻¹
 Test standard: ISO 9906 – Annex A

PERFORMANCE CURVE

50Hz

Rev. A

LPC4 100-160/1.5 (1.5 kW) MEI > 0.40 Impeller diameter = 155 mm
 LPC4 100-160/2.2 (2.2 kW) MEI > 0.40 Impeller diameter = 169 mm

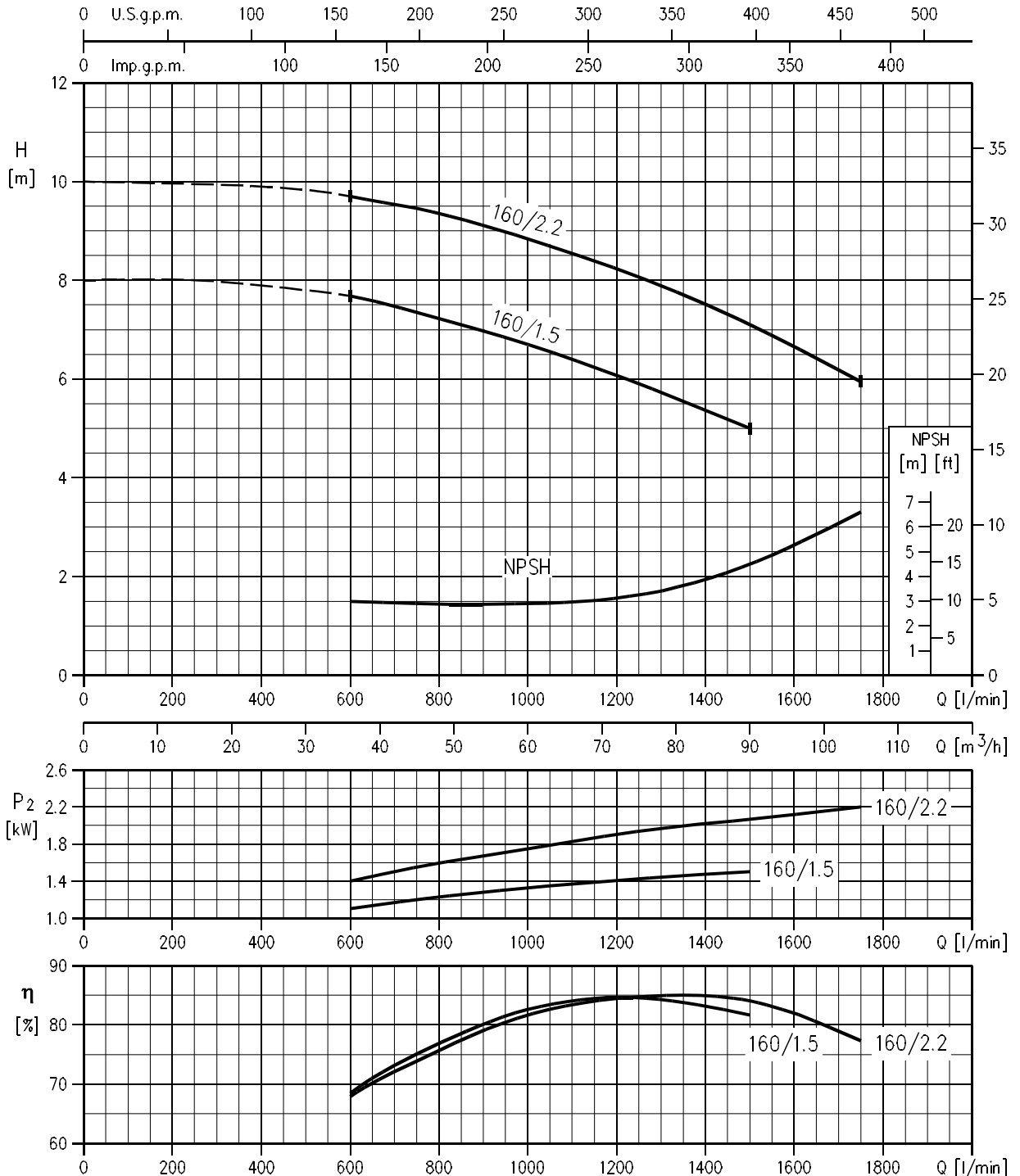

Rotation speed $\approx 1400 \text{ min}^{-1}$
 Test standard: ISO 9906 – Annex A

PERFORMANCE CURVE

50Hz

Rev. A

LPC4 100-200/3.0 (3.0 kW) MEI > 0.40 Impeller diameter = 200 mm
 LPC4 100-200/4.0 (4.0 kW) MEI > 0.40 Impeller diameter = 209 mm

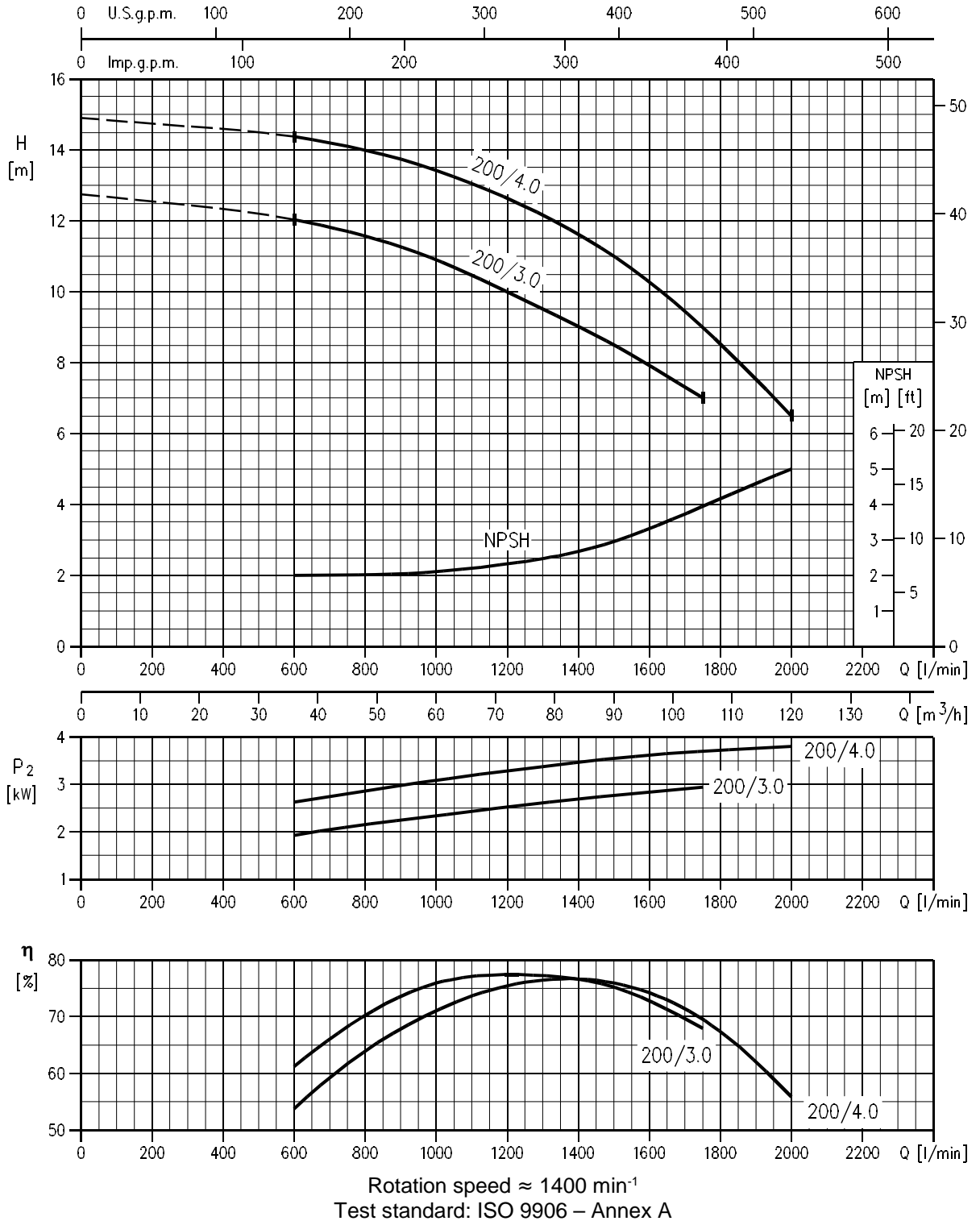

PERFORMANCE CURVE

50Hz

Rev. A

LPC4 100-250/5.5 (5.5 kW) MEI > 0.40 Impeller diameter = 240 mm
 LPC4 100-250/7.5 (7.5 kW) MEI > 0.40 Impeller diameter = 259 mm

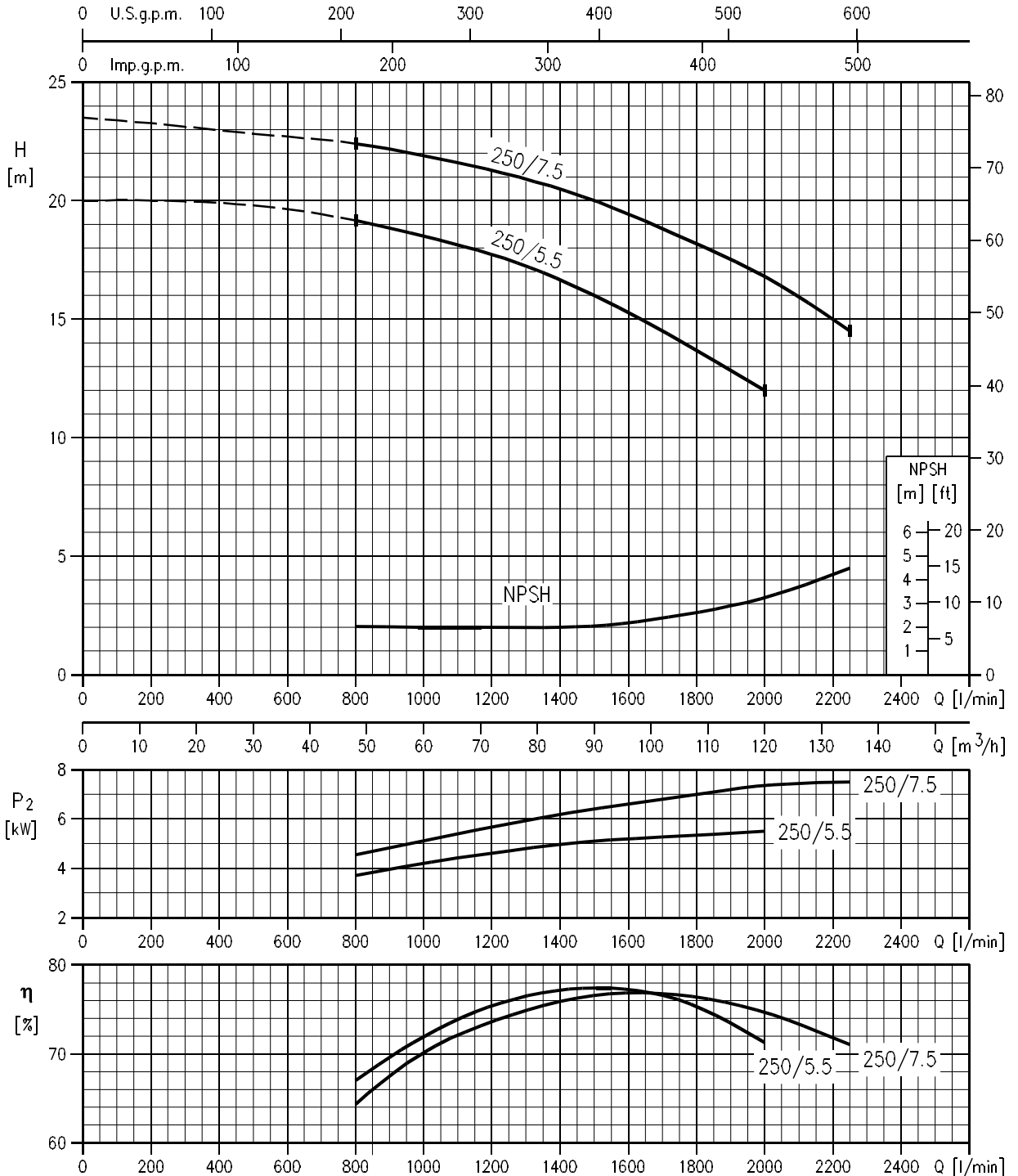

Rotation speed ≈ 1400 min⁻¹
 Test standard: ISO 9906 – Annex A

PERFORMANCE CURVE

50Hz

Rev. A

LPC4 125-250/5.5R (5.5 kW) MEI > 0.40 Impeller diameter = 198 mm
 LPC4 125-250/5.5 (5.5 kW) MEI > 0.40 Impeller diameter = 217 mm
 LPC4 125-250/7.5 (7.5 kW) MEI > 0.40 Impeller diameter = 242 mm
 LPC4 125-250/11 (11 kW) MEI > 0.40 Impeller diameter = 259 mm

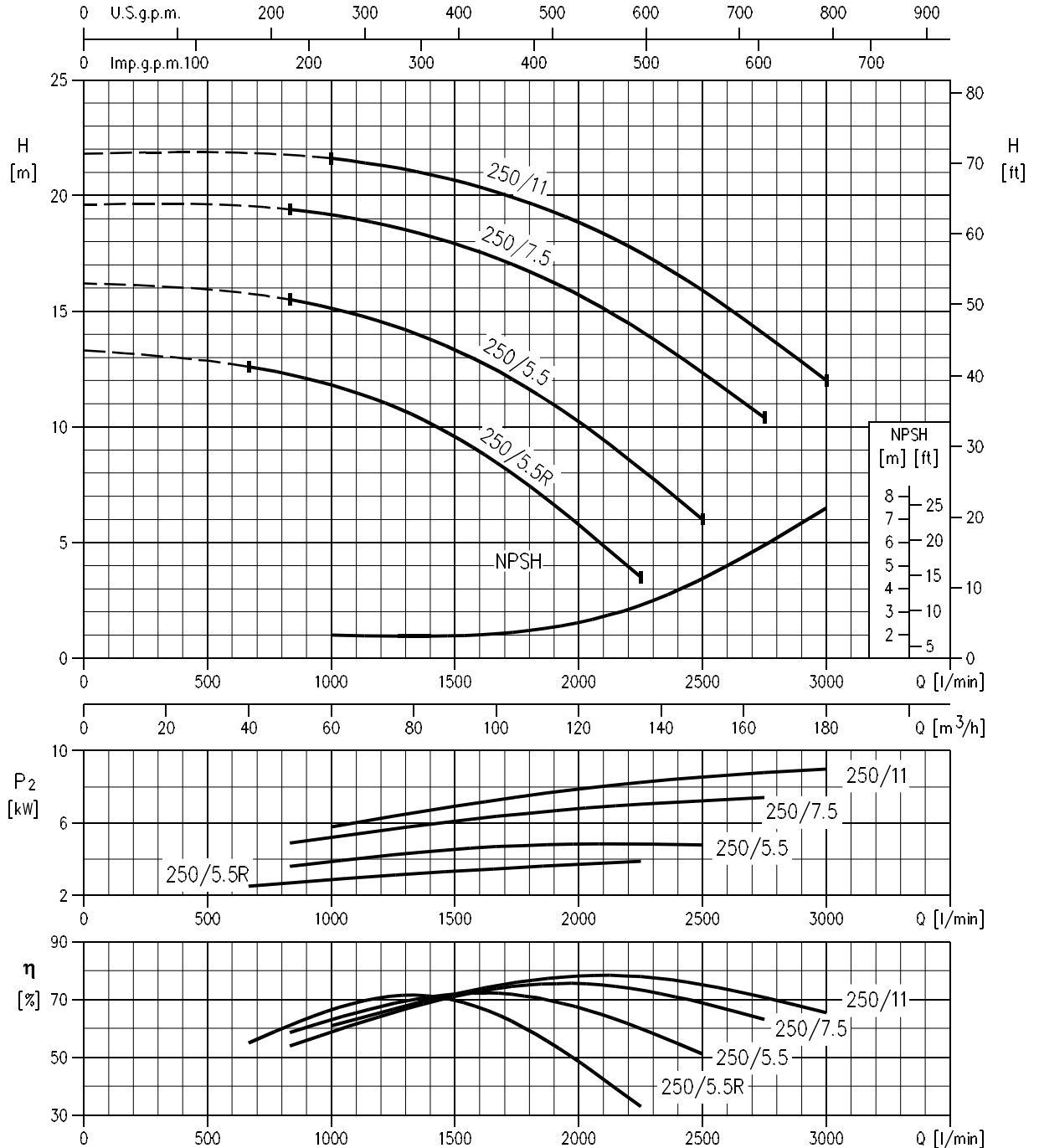

Rotation speed ≈ 1400 min⁻¹
 Test standard: ISO 9906 – Annex A

PERFORMANCE CURVE

50Hz

Rev. A

LPC4 150-250/7.5 (7.5 kW) MEI > 0.40 Impeller diameter = 225 mm
 LPC4 150-250/11R (11 kW) MEI > 0.40 Impeller diameter = 238 mm
 LPC4 150-250/11 (11 kW) MEI > 0.40 Impeller diameter = 245 mm
 LPC4 150-250/15R (15 kW) MEI > 0.40 Impeller diameter = 255 mm
 LPC4 150-250/15 (15 kW) MEI > 0.40 Impeller diameter = 259 mm

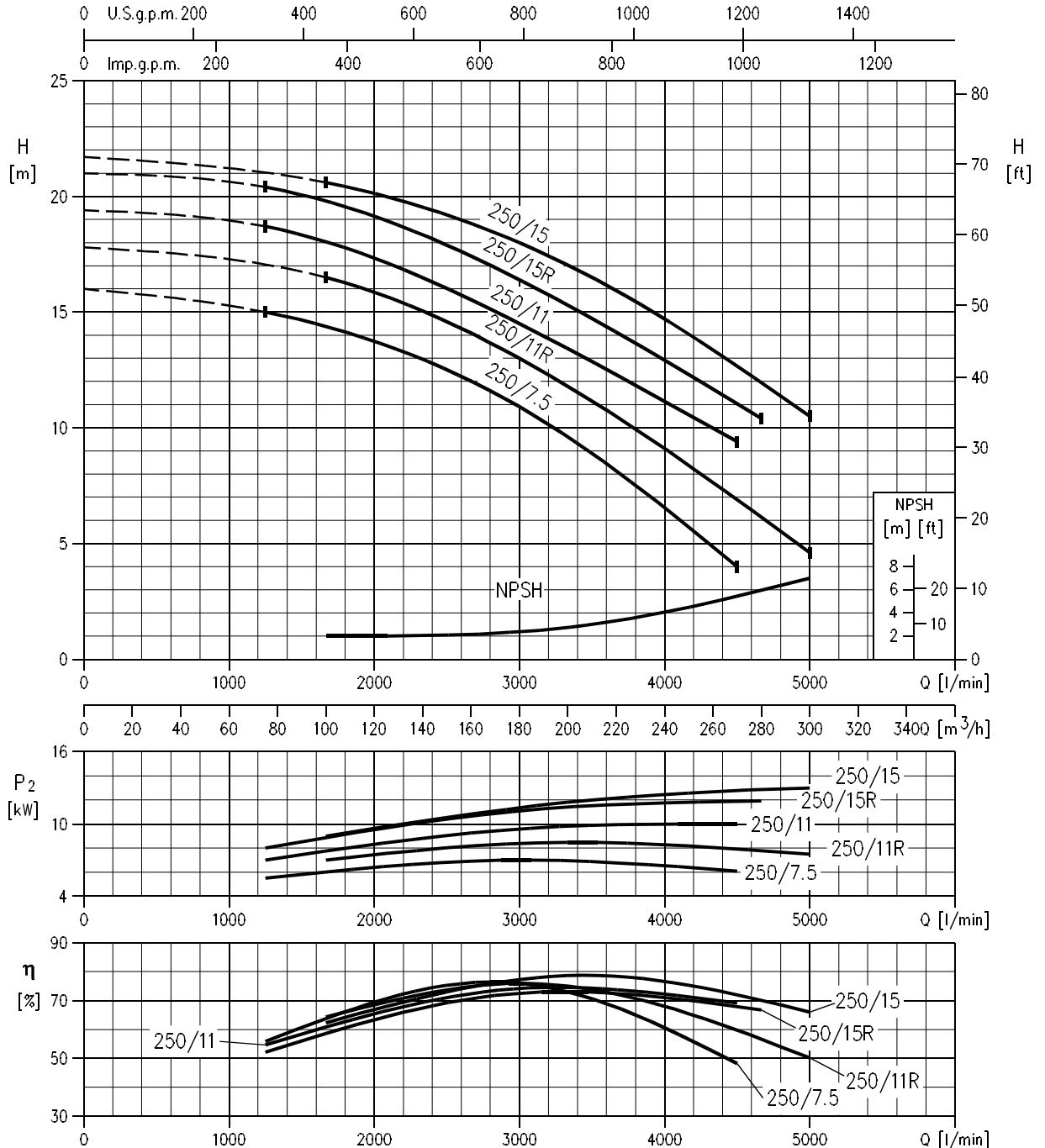

Rotation speed ≈ 1400 min⁻¹
 Test standard: ISO 9906 – Annex A

SECTIONAL VIEW DRAWING

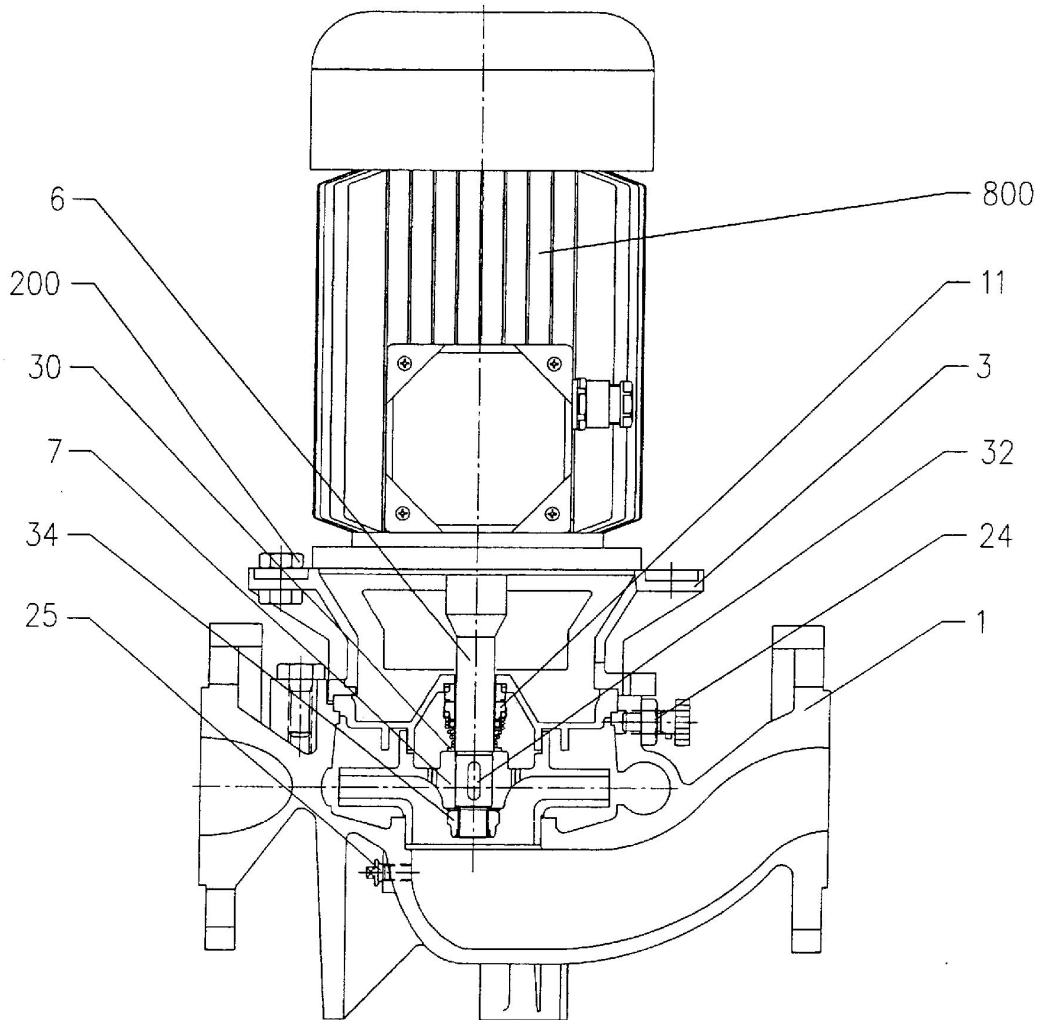

N°	PART NAME	MATERIAL
1	Casing	Cast Iron
3	Motor bracket	Cast Iron
6	Shaft with rotor	AISI 420
7	Impeller	Cast Iron
11	Mechanical seal	Carbon/SiC/EPDM
24	Priming plug	Stainless Steel
25	Drain plug	Stainless Steel
30	Spacer	Stainless steel
32	Key	Stainless steel
34	Impeller nut	Stainless steel
200	Screw	Stainless steel
800	Motor frame with stator	Alluminum

MECHANICAL SEAL

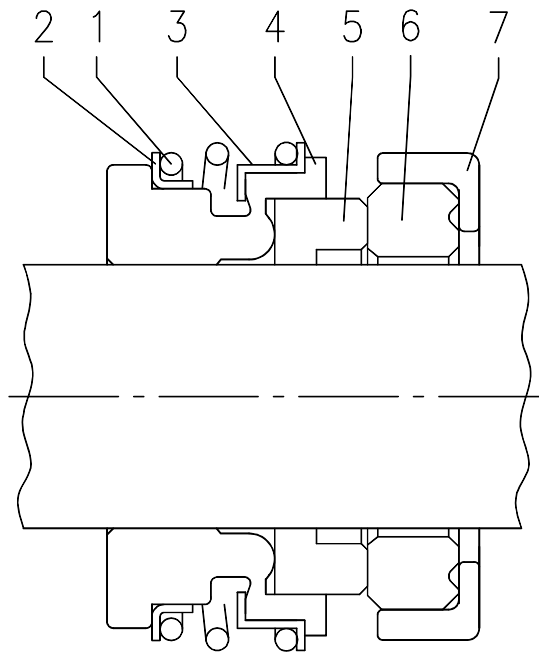

REF	PART NAME	MATERIAL (Max temperature: +110°C)
1	Spring	AISI 316
2	O Ring	EPDM
3	Frame	AISI 316
4	O Ring	EPDM
5	Rotating part	Carbon
6	Fixed part	SiC
7	Rubber cover	EPDM

PUMP LPC

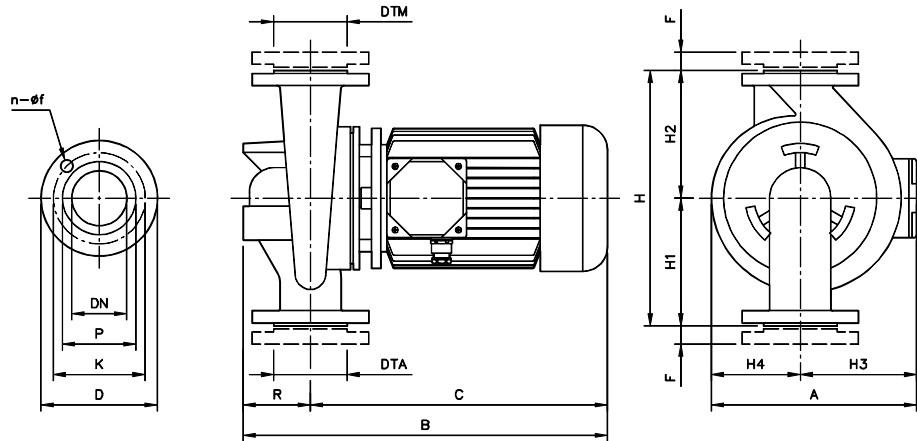

three phase	Dimensions (mm)															Weight (kgf)		
	DTA/M	DNA/M	n	f	P	K	D	H	H1	H2	H3	H4	R	F	A		B	C
LPC4 32-100/0,25	G 1 1/4	32PN10	4	14	70	90	120	220	110	110	112	65	65	16	177	379	314	12
LPC4 40-100/0,25	G 1 1/2	40PN10	4	14	80	100	130	260	140	120	112	77	90	16	189	407	317	16
LPC4 40-125/0,25R	G 1 1/2	40PN16	4	18	88	110	150	300	160	140	112	93	100	20	205	429	329	20
LPC4 40-125/0,25	G 1 1/2	40PN16	4	18	88	110	150	300	160	140	112	93	100	20	205	429	329	20
LPC4 40-160/0,37	G 1 1/2	40PN16	4	18	88	110	150	320	170	150	112	108	100	20	220	429	329	23
LPC4 40-200/0,75	G 1 1/2	40PN16	4	18	88	110	150	380	200	180	139	127	100	20	266	446	346	32
LPC4 40-200/1,1	G 1 1/2	40PN16	4	18	88	110	150	380	200	180	148	127	100	20	275	481	381	37
LPC4 40-250/1,1	G 1 1/2	40PN16	4	18	88	110	150	440	230	210	148	165	100	20	313	481	381	52
LPC4 40-250/1,5	G 1 1/2	40PN16	4	18	88	110	150	440	230	210	148	165	100	20	313	481	381	55
LPC4 50-125/0,25	G 2	50PN16	4	18	102	125	165	322	182	140	112	103	110	22	215	439	329	21
LPC4 50-125/0,37	G 2	50PN16	4	18	102	125	165	322	182	140	112	103	110	22	215	439	329	22
LPC4 50-160/0,55	G 2	50PN16	4	18	102	125	165	340	180	160	112	113	110	22	225	439	329	25
LPC4 50-200/1,1R	G 2	50PN16	4	18	102	125	165	400	220	180	148	131	110	22	279	491	381	40
LPC4 50-200/1,1	G 2	50PN16	4	18	102	125	165	400	220	180	148	131	110	22	279	491	381	40
LPC4 50-250/1,5	G 2	50PN16	4	18	102	125	165	440	230	210	148	165	125	22	313	506	381	53
LPC4 50-250/2,2	G 2	50PN16	4	18	102	125	165	440	230	210	155	165	125	22	320	545	420	57
LPC4 65-125/0,37	G 2 1/2	65PN16	4	18	122	145	185	360	205	155	112	108	140	22	220	469	329	25
LPC4 65-125/0,55	G 2 1/2	65PN16	4	18	122	145	185	360	205	155	112	108	140	22	220	469	329	26
LPC4 65-160/0,75	G 2 1/2	65PN16	4	18	122	145	185	400	220	180	139	122	140	22	261	486	346	34
LPC4 65-160/1,1	G 2 1/2	65PN16	4	18	122	145	185	400	220	180	148	122	140	22	270	521	381	39
LPC4 65-200/1,1	G 2 1/2	65PN16	4	18	122	145	185	440	240	200	148	136	140	22	284	521	381	41
LPC4 65-200/1,5	G 2 1/2	65PN16	4	18	122	145	185	440	240	200	148	136	140	22	284	521	381	42
LPC4 65-250/2,2	G 2 1/2	65PN16	4	18	122	145	185	475	250	225	155	165	140	22	320	560	420	67
LPC4 65-250/3	G 2 1/2	65PN16	4	18	122	145	185	475	250	225	155	165	140	22	320	594	454	68
LPC4 80-160/0,75	G 3	80PN16	8	18	138	160	200	440	240	200	139	131	160	24	270	506	346	51
LPC4 80-160/1,1R	G 3	80PN16	8	18	138	160	200	440	240	200	148	131	160	24	279	541	381	57
LPC4 80-160/1,1	G 3	80PN16	8	18	138	160	200	440	240	200	148	131	160	24	279	541	381	41
LPC4 80-160/1,5	G 3	80PN16	8	18	138	160	200	440	240	200	148	131	160	24	279	541	381	42
LPC4 80-200/2,2	G 3	80PN16	8	18	138	160	200	500	275	225	155	146	160	24	301	580	420	52
LPC4 80-200/3	G 3	80PN16	8	18	138	160	200	500	275	225	155	146	160	24	301	614	454	59
LPC4 80-250/4	G 3	80PN16	8	18	138	160	200	530	280	250	171	168	160	24	339	614	454	83
LPC4 80-250/5,5	G 3	80PN16	8	18	138	160	200	530	280	250	195	168	160	24	363	651	491	107
LPC4 100-160/1,5	G 4	100PN16	8	18	158	180	220	525	300	225	148	136	190	26	284	571	381	46
LPC4 100-160/2,2	G 4	100PN16	8	18	158	180	220	525	300	225	155	136	190	26	291	610	420	51
LPC4 100-200/3	G 4	100PN16	8	18	158	180	220	550	300	250	155	156	190	26	311	656	468	68
LPC4 100-200/4	G 4	100PN16	8	18	158	180	220	550	300	250	171	156	190	26	327	644	454	72
LPC4 100-250/5,5	G 4	100PN16	8	18	158	180	220	600	320	280	195	176	190	26	371	701	511	109
LPC4 100-250/7,5	G 4	100PN16	8	18	158	180	220	600	320	280	195	176	190	26	371	741	551	119
LPC4 125-250/5,5R	G 5	125PN16	8	18	188	210	250	620	340	280	195	195	195	26	390	706	511	145
LPC4 125-250/5,5	G 5	125PN16	8	18	188	210	250	620	340	280	195	195	195	26	390	706	511	145
LPC4 125-250/7,5	G 5	125PN16	8	18	188	210	250	620	340	280	195	195	195	26	390	746	551	148
LPC4 125-250/11	G 5	125PN16	8	18	188	210	250	620	340	280	238	195	195	26	433	861	666	188
LPC4 150-250/7,5	G 6	150PN16	8	22	212	240	285	700	370	330	195	210	220	28	405	802	582	167
LPC4 125-250/11R	G 6	150PN16	8	22	212	240	285	700	370	330	195	210	220	28	405	895	675	196
LPC4 150-250/11	G 6	150PN16	8	22	212	240	285	700	370	330	195	210	220	28	405	895	675	208
LPC4 150-250/15R	G 6	150PN16	8	22	212	240	285	700	370	330	238	210	220	28	448	939	719	227
LPC4 150-250/15	G 6	150PN16	8	22	212	240	285	700	370	330	238	210	220	28	448	939	719	227

TECHNICAL DATA

50Hz

Rev. A

MOTOR DATA

Pump type Three Phase	Power		Efficiency	Input [kW]	Efficiency (% load) and power-factor				Full load current [A]			Locked rotor current [A]		
	[kW]	[HP]			η %			cos-φ	230 V	400 V	690 V	230 V	400 V	690 V
					50%	75%	100%							
LPC4 32-100/0,25	0,25	0,33	-	0,41	-	-	-	-	1,6	0,9	-	5,0	2,9	-
LPC4 40-100/0,25	0,25	0,33	-	0,41	-	-	-	-	1,6	0,9	-	5,0	2,9	-
LPC4 40-125/0,25R	0,25	0,33	-	0,41	-	-	-	-	1,6	0,9	-	5,0	2,9	-
LPC4 40-125/0,25	0,25	0,33	-	0,41	-	-	-	-	1,6	0,9	-	5,0	2,9	-
LPC4 40-160/0,37	0,37	0,5	-	0,56	-	-	-	-	2,1	1,2	-	6,9	4,0	-
LPC4 40-200/0,75	0,75	1,0	IE2	0,93	75,0	78,1	79,4	0,71	3,3	1,9	-	17,1	9,8	-
LPC4 40-200/1,1	1,1	1,5	IE2	1,33	81,4	82,7	82,5	0,77	4,3	2,5	-	26,4	15,3	-
LPC4 40-250/1,1	1,1	1,5	IE2	1,33	81,4	82,7	82,5	0,77	4,3	2,5	-	26,4	15,3	-
LPC4 40-250/1,5	1,5	2	IE2	1,81	81,0	83,5	83,0	0,77	5,9	3,4	-	46,5	26,8	-
LPC4 50-125/0,25	0,25	0,33	-	0,41	-	-	-	-	1,6	0,9	-	5,0	2,9	-
LPC4 50-125/0,37	0,37	0,5	-	0,56	-	-	-	-	2,1	1,2	-	6,9	4,0	-
LPC4 50-160/0,55	0,55	0,75	-	0,80	-	-	-	-	2,8	1,6	-	10,0	5,7	-
LPC4 50-200/1,1R	1,1	1,5	IE2	1,33	81,4	82,7	82,5	0,77	4,3	2,5	-	26,4	15,3	-
LPC4 50-200/1,1	1,1	1,5	IE2	1,33	81,4	82,7	82,5	0,77	4,3	2,5	-	26,4	15,3	-
LPC4 50-250/1,5	1,5	2	IE2	1,81	81,0	83,5	83,0	0,77	5,9	3,4	-	46,5	26,8	-
LPC4 50-250/2,2	2,2	3	IE2	2,61	84,0	85,3	85,1	0,74	8,9	5,1	-	53,0	30,6	-
LPC4 65-125/0,37	0,37	0,5	-	0,56	-	-	-	-	2,1	1,2	-	6,9	4,0	-
LPC4 65-125/0,55	0,55	0,75	-	0,80	-	-	-	-	2,8	1,6	-	10,0	5,7	-
LPC4 65-160/0,75	0,75	1,0	IE2	0,93	75,0	78,1	79,4	0,71	3,3	1,9	-	17,1	9,8	-
LPC4 65-160/1,1	1,1	1,5	IE2	1,33	81,4	82,7	82,5	0,77	4,3	2,5	-	26,4	15,3	-
LPC4 65-200/1,1	1,1	1,5	IE2	1,33	81,4	82,7	82,5	0,77	4,3	2,5	-	26,4	15,3	-
LPC4 65-200/1,5	1,5	2	IE2	1,81	81,0	83,5	83,0	0,77	5,9	3,4	-	46,5	26,8	-
LPC4 65-250/2,2	2,2	3	IE2	2,61	84,0	85,3	85,1	0,74	8,9	5,1	-	53,0	30,6	-
LPC4 65-250/3	3	4	IE2	3,47	82,6	84,7	86,4	0,77	11,3	6,5	-	95,7	55,3	-
LPC4 80-160/0,75	0,75	1,0	IE2	0,93	75,0	78,1	79,4	0,71	3,3	1,9	-	17,1	9,8	-
LPC4 80-160/1,1R	1,1	1,5	IE2	1,33	81,4	82,7	82,5	0,77	4,3	2,5	-	26,4	15,3	-
LPC4 80-160/1,1	1,1	1,5	IE2	1,33	81,4	82,7	82,5	0,77	4,3	2,5	-	26,4	15,3	-
LPC4 80-160/1,5	1,5	2	IE2	1,81	81,0	83,5	83,0	0,77	5,9	3,4	-	46,5	26,8	-
LPC4 80-200/2,2	2,2	3	IE2	2,61	84,0	85,3	85,1	0,74	8,9	5,1	-	53,0	30,6	-
LPC4 80-200/3	3	4	IE2	3,47	82,6	84,7	86,4	0,77	11,3	6,5	-	95,7	55,3	-
LPC4 80-250/4	4	5,5	IE2	4,59	86,0	87,3	87,1	0,78	14,8	8,5	-	89,7	51,8	-
LPC4 80-250/5,5	5,5	7,5	IE2	6,16	87,5	88,3	88,1	0,78	-	11,4	6,6	-	84,4	48,7
LPC4 100-160/1,5	1,5	2	IE2	1,81	81,0	83,5	83,0	0,77	5,9	3,4	-	46,5	26,8	-
LPC4 100-160/2,2	2,2	3	IE2	2,61	84,0	85,3	85,1	0,74	8,9	5,1	-	53,0	30,6	-
LPC4 100-200/3	3	4	IE2	3,47	82,6	84,7	86,4	0,77	11,3	6,5	-	95,7	55,3	-
LPC4 100-200/4	4	5,5	IE2	4,59	86,0	87,3	87,1	0,78	14,8	8,5	-	89,7	51,8	-
LPC4 100-250/5,5	5,5	7,5	IE2	6,16	87,5	88,3	88,1	0,78	-	11,4	6,6	-	84,4	48,7
LPC4 100-250/7,5	7,5	10	IE3	8,41	88,5	89,4	89,2	0,74	-	16,4	9,5	-	121,4	70,1
LPC4 125-250/5,5R	5,5	7,5	IE2	6,16	87,5	88,3	88,1	0,78	-	11,4	6,6	-	84,4	48,7
LPC4 125-250/5,5	5,5	7,5	IE2	6,16	87,5	88,3	88,1	0,78	-	11,4	6,6	-	84,4	48,7
LPC4 125-250/7,5	7,5	10	IE3	8,41	88,5	89,4	89,2	0,74	-	16,4	9,5	-	121,4	70,1
LPC4 125-250/11	11	15	IE3	12,49	89,4	90,3	90,1	0,82	-	22,0	12,7	-	173,8	100,3
LPC4 150-250/7,5	7,5	10	IE3	8,41	88,5	89,4	89,2	0,74	-	16,4	9,5	-	121,4	70,1
LPC4 150-250/11R	11	15	IE3	12,49	89,4	90,3	90,1	0,82	-	22,0	12,7	-	173,8	100,3
LPC4 150-250/11	11	15	IE3	12,49	89,4	90,3	90,1	0,82	-	22,0	12,7	-	173,8	100,3
LPC4 150-250/15R	15	20	IE3	16,87	90,6	91,2	91,0	0,84	-	29,0	16,7	-	214,6	123,9
LPC4 150-250/15	15	20	IE3	16,87	90,6	91,2	91,0	0,84	-	29,0	16,7	-	214,6	123,9

NOISE DATA

Pump type	Power		L _{pA} - dB(A) *
	[kW]	[HP]	
LPC4 32-100/0,25	0.25	0.33	<70
LPC4 40-100/0,25	0.25	0.33	
LPC4 40-125/0,25R	0.25	0.33	
LPC4 40-125/0,25	0.25	0.33	
LPC4 40-160/0,37	0.37	0.55	
LPC4 40-200/0,75	0.75	1	
LPC4 40-200/1,1	1.1	1.5	
LPC4 40-250/1,1	1.1	1.5	
LPC4 40-250/1,5	1.5	2	
LPC4 50-125/0,25	0.25	0.3	
LPC4 50-125/0,37	0.37	0.55	
LPC4 50-160/0,55	0.55	0.75	
LPC4 50-200/1,1R	1.1	1.5	
LPC4 50-200/1,1	1.1	1.5	
LPC4 50-250/1,5	1.5	2.0	
LPC4 50-250/2,2	2.2	3	
LPC4 65-125/0,37	0.37	0.55	<70
LPC4 65-125/0,55	0.55	0.75	
LPC4 65-160/0,75	0.75	1	
LPC4 65-160/1,1	1.1	1.5	
LPC4 65-200/1,1	1.1	1.5	
LPC4 65-200/1,5	1.5	2	
LPC4 65-250/2,2	2.2	3	
LPC4 65-250/3	3	4	72
LPC4 80-160/0,75	0.75	1	<70
LPC4 80-160/1,1R	1.1	1.5	
LPC4 80-160/1,1	1.1	1.5	
LPC4 80-160/1,5	1.5	2	
LPC4 80-200/2,2	2.2	3	72
LPC4 80-200/3	3	4	
LPC4 80-250/4	4.0	5.5	78
LPC4 80-250/5,5	5.5	7.5	<70
LPC4 100-160/1,5	1.5	2	
LPC4 100-160/2,2	2.2	3	72
LPC4 100-200/3	3.00	4	
LPC4 100-200/4	4.00	5.5	78
LPC4 100-250/5,5	5.5	7.5	
LPC4 100-250/7,5	7.5	10	80
LPC4125-250/5,5R	5.5	7.5	78
LPC4 125-250/5,5	5.5	7.5	
LPC4 125-250/7,5	7.5	10	80
LPC4 125-250/11	11	15	
LPC4 150-250/7,5	7.5	10	
LPC4 150-250/11R	11	15	
LPC4 150-250/11	11	15	
LPC4 150-250/15R	15	20	
LPC4 150-250/15	15	20	

* Mean value of several measures at 1m distance around the
Tolerance ± 2.5 dB.